

CELEBRATING
54
YEARS



AUTOBAHN INDUSTRIES
TUBULAR HANDLING TOOLS AND SEPARATION SOLUTION



Hon'ble President of India Mr. Giani Zail Singh awarding India's Prestigious National Award to the founder of Autobahn Industries.

Company Profile

Autobahn Industries (ABI) is a globally recognized integrated Designing & Manufacturing company, renowned for its quality products and services. Established in 1970 in Jodhpur, Rajasthan, ABI specializes in designing, manufacturing, and supplying various Rig Floor Equipment, Handling Tools, and Solid Control Equipment for the Oil and Gas Industry. Our commitment to innovation and excellence has earned us the prestigious "National Award" from the Government of India, presented by the former Honourable President of India.

With over 54 years of experience, ABI has built a strong reputation for delivering high-quality, safe products. Our dedicated R&D and Designing Division, staffed by qualified and experienced engineers, continually innovates to ensure our products meet the latest international standards and safety norms. We are a trusted supplier to major government and private oil and gas companies in India. We have a robust export market that includes the USA, UAE, Russia, Saudi Arabia, Oman, Germany, Norway, and Vietnam, among others.

Our vision is to be the most trusted provider of Tubular Handling Tools and Separation Solutions in the Oil & Gas Industry, offering the safest and highest quality products with prompt service. Our authenticity and commitment to quality are reflected in our extensive product range, which is continually updated to incorporate the latest technological advancements.

ABI boasts a state-of-the-art infrastructure, including modern automatic manufacturing facilities equipped with world-class CNC machines, ensuring high accuracy and precision while minimizing production lead time. Our fully equipped laboratory provides comprehensive in-house testing to ensure product quality and safety at every manufacturing stage.

Our decades of experience, dedicated service, and advanced capabilities enable us to design and manufacture superior products that meet the rigorous demands of the Oil and Gas Industry while adhering to stringent safety measures. Some of our advanced production machinery includes:

1. CNC Vertical Turning Centre (Doosan, South Korea)
2. HMC Horizontal Machining Center (Doosan, South Korea)
3. CNC Vertical Machine Centre (Doosan, South Korea)
4. CNC Turn Lathe Machines

Autobahn Industries holds several prestigious licenses and certifications, including:

1. API 7K license for Rotary Bushings, Rotary Slips, Manual Tongs, Spiders, and Safety Clamps since 2001
2. ISO 9001 certification

Our products and services are the result of decades of experience, committed management, and the dedicated efforts of our skilled workforce, providing a powerful platform for designing and manufacturing quality products tailored to the needs of the Oil and Gas Industry.

Autobahn's Quality Policy

We are committed to designing, manufacturing, and supplying quality equipment and spare parts to our customers, strictly adhering to API specifications to enhance customer satisfaction. Our commitments include:

1. Designing and manufacturing equipment that meets and exceeds API-7K Specification requirements.
2. Delivering top-notch quality products promptly to clients.
3. Continually improving our products, processes, and systems through a team of competent personnel.
4. Ensuring rigorous quality control measures are in place at every stage of production to guarantee the highest standards.
5. Investing in advanced technology and equipment to maintain precision and reliability in our manufacturing processes.

“Your Trust Our Commitment”

CNC MACHINING FACILITIES





HEAT TREATMENT FACILITIES



QUALITY CONTROL AND TESTING FACILITIES

Our quality control and testing facilities are integral to our commitment to excellence. At Autobahn Industries, we ensure that every product meets the highest standards of quality and safety through rigorous testing and inspection at every stage of manufacturing. Our state-of-the-art laboratory is equipped with the latest technology for comprehensive in-house testing, ensuring our products meet international quality standards and HSE guidelines. We are dedicated to rigorously testing all products throughout the manufacturing process to guarantee their quality and safety.

Some of the tests currently conducted during manufacturing and on finished products include:

1. Spectrometer for chemical analysis
2. Material structural analysis test
3. Magnetic particle inspection
4. Ultrasonic testing
5. Radiographic testing
6. Hardness testing
7. Impact testing
8. Tensile testing
9. Dimensional and visual inspection at every manufacturing stage
10. Load Testing on a hydraulic press up to 750 sTon for Master Bushings, Rotary Slips, and Spiders
11. Hydraulic test bench with a plotter for testing up to 200,000 ft. lbs for Manual Tongs





Metallurgical Testing



Material Structural Analysis

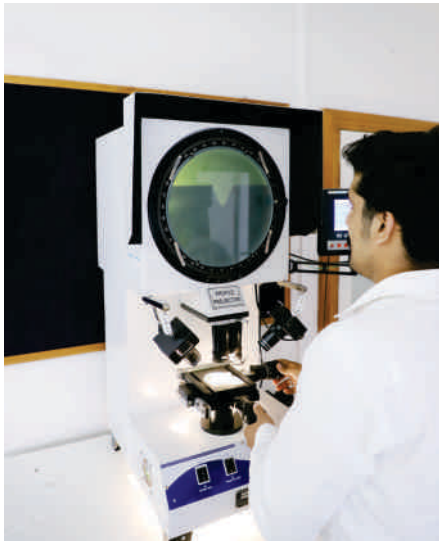

Geometrical Inspection



Impact Testing



Metrology Scanning Solution



Proof Load Testing

INDEX

S. No.	Product Details	Page No.
1.	MASTER BUSHINGS	
○	MPCH Master Bushing for National, Oilwell & EMSCO Rotary Table	1
○	Solid Body Pin Drive	2
○	Solid Body Square Drive	2
○	Split Type Pin Drive & Insert Bowls	3
○	Split Type Pin Drive having Taper of Bowl No. 3	4
○	Split Type Square Drive having Taper of Bowl No. 3	4
2.	CASING BUSHING AND INSERT BOWLS	5
3.	ADAPTER RING	6
4.	WEAR GUIDE ASSEMBLY	6
5.	ROLLER KELLY BUSHING HEAVY DUTY PIN DRIVE AND SQUARE DRIVE	7
6.	MANUAL TONGS	10
7.	MANUAL CASING TONG	13
8.	PNEUMATIC TUBING SPIDERS	15
9.	SDS, SDML, SDXL ROTARY SLIPS	17
10.	DRILL COLLAR SLIPS	19
11.	CASING SLIPS	20
12.	RHS ROTARY HAND SLIPS	22
13.	PNEUMATIC BACKSAVER	23
14.	HYDRAULIC POWER SLIP (HPS 500)	24
15.	SPRING LOADED POWER SLIP (Eq. PS 15)	27
16.	PNEUMATIC POWER SLIP (Eq. PS 16)	29
17.	SAFETY CLAMPS	31
18.	UMBILICAL / SLOTTED INSERT BOWL AND ROTARY SLIP	32
19.	VENOM SHALE SHAKERS	33
20.	SUPERFLOW SHALE SHAKERS	34
21.	MUD CLEANERS	35
22.	SHALE SHAKER SCREENS	36
23.	MUD AGITATORS	37
24.	DIES AND INSERTS	38
25.	LIFTING SLING AND BIT BREAKER ADAPTER PLATE	39

MASTER BUSHINGS

MPCH Master Bushing for National, Oilwell & EMSCO Rotary Table

Autobahn Industries is an API-approved manufacturer with a valid API-7K license for the past 23 years, specializing in Rotary Bushings (Master Bushings). Our MPCH Master Bushings are designed for rotary tables sized 37.1/2" to 49.1/2", adhering strictly to API-7K Specifications (Latest Edition) for drilling operations.

The MPCH is a pin-driven hinged Master Bushing. The Master Bushing can be configured to fit in Rotary Tables of various manufacturers and configurations on special request. The MPCH will be delivered based on customer order. With the help of Insert Bowls, it is capable of handling Drill Collar, Tubing, and Casing ranging from 2.3/8" to 13.3/8". The standard delivery with Insert Bowl No.3 is recommended by Autobahn Industries, while the optional Insert Bowl No.1 and No.2 are designed to enhance the pipe, Drill Collar, Tubing, and casing handling range.

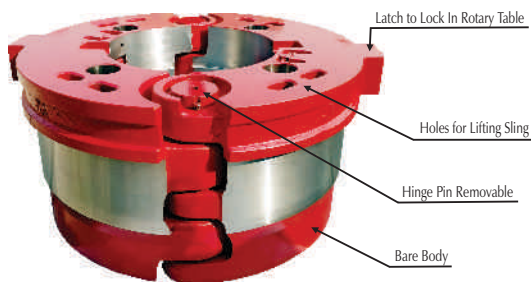

Master Bushing for National RT
Model : ABMB 3750
Figure No. 1



Master Bushing for Oilwell RT
Model : ABMB 3750-SQ
Figure No. 2

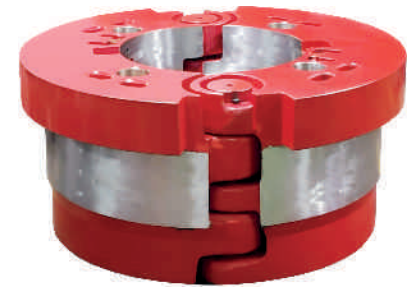

Master Bushing for EMSCO RT
Model : ABMB 3750-E
Figure No. 3

Master Bushing is supplied alongwith the following :

1. Lifting Slings: Chain Type with four hooks for Master Bushing & Two hooks for Bowl for lifting purpose.
2. Bit Breaker Adapter Plate: For makeup and breakup of bits.
3. Insert Bowls: Bowl No. 1, 2 & 3 to handle different sizes of tubular. (Optional)



Part List of ABMB 3750, ABMB 3750-SQ & ABMB 3750-E:

(All the spare parts are interchangeable with Varco MPCH or other Master Bushings that comply with API standards.)

S.No.	Description	Qty Per Unit	Identical Varco P/N For National	ABI P/N For National	ABI P/N For Oilwell	ABI P/N For EMSCO
1.	Bare body segment	1 No.	6601-1	3710	3710-SQ	3710-E
2.	Hinge Pin-Removable (with handle)	1 No.	6604	3711	3711-SQ	3711-E
3.	Hinge Pin Retainer	1 No.	6606	3711-A	3711-A-SQ	3711-A-E
4.	Hinge Pin-Stationary (with retainer)	1 No.	6605	3712	3712-SQ	3712-E
5.	Bowl lock Assembly	2 No.	-	3714	3714-SQ	3714-E
6.	Eccentric Pin	2 No.	1014	3714-A	3714-A-SQ	3714-A-E
7.	Eccentric Pin Lock	2 No.	1016	3714-B	3714-B-SQ	3714-B-E
8.	Eccentric Pin Retainer	2 No.	50106-22	3714-C	3714-C-SQ	3714-C-E
9.	Drive Hole Bushing	4 No.	3699	3715	3715-SQ	3715-E
10.	Lifting Sling for Master Bushing (Four Hook Type)	1 No.	6699	3716	3716-SQ	3716-E
11.	Bit Breaker Adapter Plate	1 No.	1816	3717	3717-SQ	3717-E
12.	Insert Bowl No: 1 For 11.3/4" to 13.3/8" tubular	1 No.	6610	3751	3751-SQ	3751-E
13.	Insert Bowl No: 2 For 9.5/8" to 10.3/4" tubular	1 No.	6609	3752	3752-SQ	3752-E
14.	Insert Bowl No: 3 For 2.3/8" to 8.5/8" tubular	1 No.	6608	3753	3753-SQ	3753-E
15.	Lifting Sling for Bowls (Two Hook Type)	1 No.	-	3754	3754	3754

SOLID BODY PIN DRIVE MASTER BUSHING

Model: ABMB2750-PS for 27.1/2" Rotary Table & ABMB2050-PS for 20.1/2" Rotary Table

The Autobahn Industries Solid Body Pin Drive Master Bushing is designed for 20.1/2" and 27.1/2" Rotary Tables, adhering to the latest API-7K Specification. This Pin Drive Master Bushing allows the use of Insert Bowls in the Rotary Table while the Kelly Bushing is in operation.

With the appropriate Insert Bowl, the Master Bushing can support a maximum string load of 500 tons. Insert Bowls offer superior slip backup and are engineered to handle heavier tubular strings without the risk of string failure due to bottlenecking. These Insert Bowls, also compliant with API-7K specifications, can accommodate tubular sizes ranging from 2.3/8" to 13.3/8".

The Model ABMB2750-PS Master Bushings are equipped with bowl locks to securely hold the Insert Bowls in place.



27.1/2" Solid Type Master Bushing
Model : ABMB 2750-PS
Figure No. 5



20.1/2" Solid Type Master Bushing
Model : ABMB 2050-PS
Figure No. 6

Part List of Solid Body Pin Drive Master Bushing:

(Interchangeable with Varco MSPC or any other Master Bushings that comply with API-7K standard)

S.No.	Description	Qty. Per Unit	P/N For ABMB 2750-PS	P/N For ABMB 2050-PS
1.	Bare Body	1 No.	2751-PS	2051-PS
2.	Bowl Lock Assembly	2 No.	2752-PS	2052-PS
3.	Drive Hole Bushing	4 No.	2753-PS	2053-PS
4.	Lifting Sling (Two Hooks Type)	1 No.	2754-PS	2054-PS
5.	Bit Breaker Adapter Plate	1 No.	2755-PS	2055-PS
6.	Insert Bowl No.1 For 11.3/4" to 13.3/8" Tubular	1 No.	2756-PS	–
7.	Insert Bowl No.2 For 9.5/8" to 10.3/4" Tubular	1 No.	2757-PS	2057-PS
8.	Insert Bowl No.3 For 2.3/8" to 8.5/8" Tubular	1 No.	2758-PS	2058-PS

SOLID BODY SQUARE DRIVE MASTER BUSHING

Model: ABMB2750-SS for 27.1/2" Rotary Table & ABMB2050-SS for 20.1/2" Rotary Table

The Square Drive Master Bushing, compliant with API-7K specifications, is ideal for drilling operations up to 10,000 feet where a large slip backup area is not required. The Solid Outer Body is engineered to support all transverse loads and provides suitable backing for Split Insert Bowls, even during active drilling with the Rotary Table.

Model ABMB 2050-SS accommodates tubular sizes ranging from 2.3/8" to 10.3/4" OD, while Model ABMB 2750-SS handles tubular sizes from 2.3/8" to 13.3/8" OD, utilizing Insert Bowls.

The following are the recommended accessories for these Master Bushings:

1. Bit Breaker Adapter Plate.
2. Lifting sling.
3. Insert Bowl No.1,2 & 3

Part List of Solid Body Square Drive Master Bushing:

(Interchangeable with Varco MSS or any other Master Bushings that comply with API-7K standard)

S.No.	Description	Qty. Per Unit	P/N For ABMB 2750-SS	P/N For ABMB 2050-SS
1.	Bare Body	1 No.	2751-SS	2051-SS
2.	Bowl Lock Assembly	2 No.	2752-SS	2052-SS
3.	Lifting Sling (Two Hooks Type)	1 No.	2754-SS	2054-SS
4.	Insert Bowl No.1 For 11.3/4" to 13.3/8" Tubular	1 No.	2756-SS	–
5.	Insert Bowl No.2 For 9.5/8" to 10.3/4" Tubular	1 No.	2757-SS	2057-SS
6.	Insert Bowl No.3 For 2.3/8" to 8.5/8" Tubular	1 No.	2758-SS	2058-SS

Note: In addition to the standard models, Master Bushings can also be custom-made to meet specific customer requirements upon request.

SPLIT TYPE PIN DRIVE MASTER BUSHING

Model: ABMB2750-PSP-3

Autobahn Industries manufactures Split Type Pin Drive Master Bushings designed for 27.1/2" Rotary Tables, adhering strictly to the latest API-7K specifications. We hold a valid API-7K Monogram for our Master Bushings. These Master Bushings are compatible with Insert Bowls No. 1, 2, and 3, allowing them to handle various sizes of tubulars, including Drill Collars, Tubing, and Casing ranging from 2.3/8" to 13.3/8".

The advantages of the Split Type Pin Drive Master Bushing include:

1. The Master Bushing can be easily removed to allow large-diameter bits and pipe connections to pass through.
2. The BOP (Blowout Preventer) can be easily lifted by removing the Master Bushing from the Rotary Table.
3. The Master Bushing can be securely locked into the Rotary Table, with locks that firmly hold the Insert Bowls in place.

The following are the recommended accessories for this Master Bushing:

1. Bit Breaker Adapter Plate.
2. Liftingsling.
3. Insert Bowl No.1,2 & 3

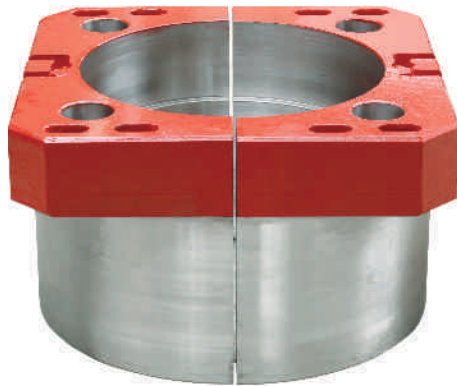

27.1/2" Split Master Bushing
Figure No. 7



Figure No. 8

Part List of Split Type Pin Drive Master Bushing:

S.No.	Description	Qty. Per Unit	P/N
1.	Bare Body	1 No.	2751-PSP-3
2.	Bowl Lock Assembly	2 No.	2752-PSP-3
3.	Drive Hole Bushing	4 No.	2753-PSP-3
4.	Lifting Sling (Two Hooks Type)	1 No.	2754-PSP-3
5.	Bit Breaker Adapter Plate	1 No.	2755-PSP-3
6.	Insert Bowl No.1 For 11.3/4" to 13.3/8" Tubular	1 No.	2756-PSP-3
7.	Insert Bowl No.2 For 9.5/8" to 10.3/4" Tubular	1 No.	2757-PSP-3
8.	Insert Bowl No.3 For 2.3/8" to 8.5/8" Tubular	1 No.	2758-PSP-3

MEDIUM DUTY SPLIT TYPE PIN DRIVE MASTER BUSHING - BOWL 3 TAPER DESIGN

Model: ABMB 2750-PSP for 27.1/2" RT ABMB 2050-PSP for 20.1/2" RT
 ABMB 1750-PSP for 17.1/2" RT ABMB 2750-SSP for 27.1/2" RT

These Master Bushings are designed for shallow to medium-depth wells, compatible with 17.1/2", 20.1/2", and 27.1/2" Rotary Tables. Manufactured in strict accordance with API-7K specifications, the PSP (Pin Drive Split Type) and SSP (Square Drive Split Type) models feature a standard taper of Insert Bowl No. 3, accommodating tubular sizes from 2.3/8" to 8.5/8". These models also allow the use of extra-long SDXL slips for handling heavier loads.

The 2.1/2" rise in taper facilitates easier slip handling, uniformly distributing the load within the Master Bushing and reducing wear and tear on the table bore. This design provides 50% more slip support, enhancing load management capability. The 27.1/2" Master Bushing is engineered to handle string loads up to 500 tons.



27.1/2" Split & Inbuilt Taper Master Bushing
 Model : ABMB 2750-PSP
 Figure No. 9



20.1/2" Split & Inbuilt Taper Master Bushing
 Model : ABMB 2050-PSP
 Figure No. 10

The following are the recommended accessories for these Master Bushings:

1. Bit Breaker Adapter Plate.
2. Lifting sling.

Part List of Split Type Pin Drive Master Bushing:

(Interchangeable with Varco MSP & MDSP or other Master Bushing of API standard)

S. No.	Description	Qty. Per Unit	P/N For ABMB 2750-PSP	P/N For ABMB 2050-PSP	P/N For ABMB 1750-PSP
1.	Bare Body	1 No.	2751-PSP	2051-PSP	1751-PSP
2.	Drive Hole Bushing	4 No.	2753-PSP	2053-PSP	-
3.	Lifting Sling (Two Hooks Type)	1 No.	2754-PSP	2054-PSP	1754-PSP
4.	Bit Breaker Adapter Plate	1 No.	2755-PSP	2055-PSP	1755-PSP

MEDIUM DUTY SPLIT TYPE SQUARE DRIVE MASTER BUSHING

Model : ABMB 2750-SSP for 27.1/2" Rotary Table

Part List of Split Type Square Drive Master Bushing:

S. No.	Description	Qty. Per Unit	P/N
1.	Bare Body	1 No.	2751-SSP
2.	Lifting Sling (Two Hooks Type)	1 No.	2754-SSP

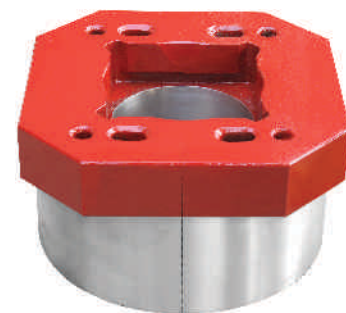

27.1/2" Split & Inbuilt Taper Master Bushing
 Figure No. 11

Note: In addition to the standard models, Master Bushings can also be custom-made to meet specific customer requirements upon request.

CASING BUSHINGS AND INSERT BOWLS

When the casing is inserted into a drilled hole, the casing string must align precisely with the hole's center. This alignment ensures that cement slurry is evenly distributed around the casing, promoting effective bonding between the casing and the borehole. Casing Bushings are employed to ensure that the casing being run maintains perfect alignment with the center of the hole.

Casing Bushings are available in either solid or split types, and all variants can accommodate bowls of different sizes to cater to a wide range of casing dimensions. They are directly installed into the Rotary Table, and by using CMS-XL or CP-S slips, the casing string can be easily rotated during cementing operations. Casing Bushings are designed to handle string loads of up to 500 tons.



27.1/2" Split Casing Bushing
Figure No. 12

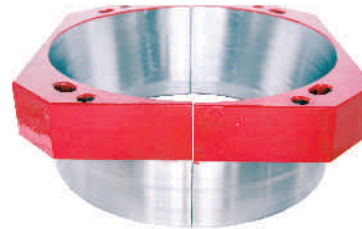

Split Casing Bushing for 37.1/2"-49.1/2" Oilwell RT
Figure No. 13



Casing Bowl No. 1



Casing Bowl No. 2



Casing Bowl No. 3

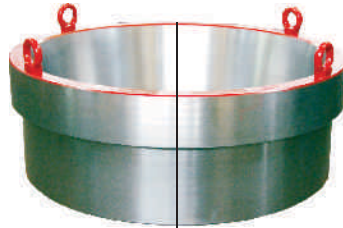

Split Casing Bushing for 37.1/2"-49.1/2" National RT
Figure No. 14



Split Casing Bushing for 37.1/2"-49.1/2" National RT
Figure No. 15



Casing Bowl No. 16

Rotary Table Size	Suitable for R.T.	Casing Size (In Inches)	Casing Bushing P/N	Insert Bowl P/N
27.1/2"	All Types	18.5/8 & 20	ABSCB-2540	—
		16	—	Bowl No. 16 - 2541
		11.3/4 & 13.3/8	—	Bowl No. 1 - 2542
		9.5/8 & 10.3/4	—	Bowl No. 2 - 2543
		8.5/8 & Smaller	—	Bowl No. 3 - 2545
37.1/2"-49.1/2"	Oilwell	30	ABSCB-2550-SQ	—
		18.5/8 & 20	ABSCB-2553-SQ	—
37.1/2"-49.1/2"	National	30	ABSCB-2550	—
		26	ABSCB-2551	—
		24	ABSCB-2552	—
		18.5/8 & 20	ABSCB-2553	—
		16	—	Bowl No. 16 - 2554
		11.3/4 & 13.3/8	—	Bowl No. 1 - 2555
		9.5/8 & 10.3/4	—	Bowl No. 2 - 2556
		8.5/8 & Smaller	—	Bowl No. 3 - 2558
Lifting Sling for Casing Bushing (Two Hooks Type)			ABSCB-2554	—
Lifting Sling for Casing Bowls (Two Hooks Type)			—	ABSCB-2555

Recommended Accessories with Casing Bushing are: 1. Lifting Sling 2. Insert Bowl No. 1,2,3 & 16 (Optional)

Note: Casing Bushings can also be custom-made according to specific customer requirements upon request.

ADAPTER RING

Autobahn produces a diverse selection of Rotary Adapter Rings or Reducer Bushings designed for 75.1/2", 60.1/2", 49.1/2" and 37.1/2" Rotary Tables. These adapter rings serve the purpose of reducing the rotary bore size. They come in both solid and hinged designs, offering versatility in application. Additionally, the configurations of these rings can vary from one rotary maker to another or even from one brand to a different brand (e.g., Oilwell to National). Autobahn is API-7K Certified for Rotary Bushings which includes Adapter Rings and these Adapter Rings are made strictly following the latest edition of API-7K specifications.

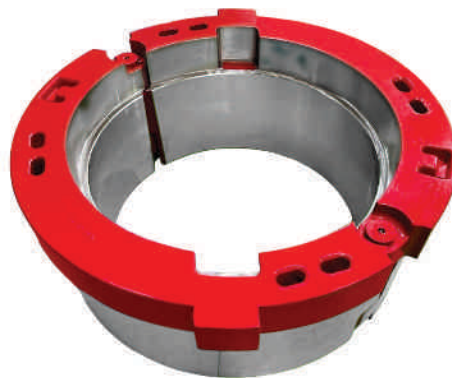

Adapter Ring
Figure No. 16

Types of Adapter Rings:

S.No.	Reducing Size	Type	Rated Load (sTon)	Part No.
1.	NOV 75.1/2" to NOV 60.1/2" RT	Hinged	1500	6001
2.	NOV 60.1/2" to National 49.1/2" RT	Hinged	1500	6002
3.	From National 49.1/2" to National 37.1/2" RT	Hinged	1500	6003
4.	From National 49.1/2" to National 37.1/2" RT	Solid	1500	6004
5.	From National 37.1/2" to API Standard 27.1/2" RT	Hinged	750	6005
6.	From Oilwell 37.1/2" to API Standard 27.1/2" RT	Hinged	750	6006
7.	From EMSCO 37.1/2" to API Standard 27.1/2" RT	Hinged	750	6007

Note: Customized Adapter Rings are also available upon request.

WEAR GUIDE ASSEMBLY

The Wear Guide Assembly is essential for minimizing wear and tear on Master Bushings and Insert Bowls during drilling operations, particularly when using a top drive. It plays a crucial role in protecting the drilling string by centralizing it, thereby reducing the risk of damage to the insert bowls throughout the drilling or tripping process.

This assembly is specifically designed to be mounted directly into the pin drive locations on 27.1/2" & 37.1/2" Master Bushings. With the assistance of Insert Sets, the Wear Guide Assembly can accommodate tubular sizes ranging from 3.1/2" to 6.5/8".

Technical Specification:

S.No.	Pipe Size	Part No.
1.	3.1/2"-5"	65850
2.	5.1/2"-6.5/8"	65851

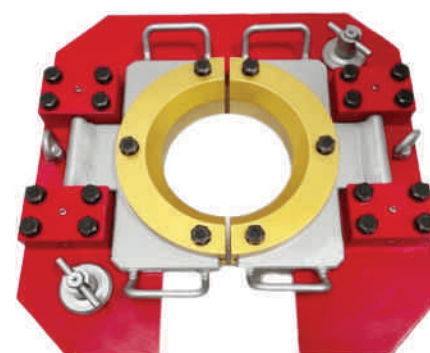

Wear Guide Assembly
Figure No. 17

KELLY BUSHINGS

Kelly Bushing Pin Drive

Model: 27 PDHD and 20 PDHD

Autobahn Industries is an API-approved manufacturer for Rotary Bushings (which includes Kelly Bushings), with a valid API-7K License for the past 23 years, we ensure compliance with industry standards.

Our Kelly Bushing models, 27PDHD or 20PDHD, are manufactured following API-7K specifications. They are designed for pin drive Master Bushings, suitable for Rotary Table sizes ranging from 27.1/2" to 49.1/2", Master Bushing with 25.3/4" pin circle 27PDHD of 23" pin circle, 20PDHD. The Kelly Bushing is utilized in drilling operations, particularly in high torque conditions, both offshore and onshore. It effectively handles Square or Hexagonal Kelly sizes ranging from 3" to 6".

The Kelly Bushing is supplied with the following components:

1. Roller Assembly (Pre-fitted)
2. Wiper Assembly (Pre-fitted)
3. Wrench
4. Wear Gauge



Pin Drive Kelly Bushing
Figure No. 18

Kelly Bushing Square Drive

Model: SDHD

The Kelly Bushing Model SDHD conforms to API-7K specifications for Square Drive Master Bushings, designed for Rotary Table sizes ranging from 27.1/2" to 49.1/2". It is utilized in drilling operations, both Offshore and Onshore, particularly in high torque conditions, and is capable of handling Square or Hexagonal Kelly sizes from 3" to 6".

The Kelly Bushing is supplied with the following components:

1. Roller Assembly (Pre-fitted)
2. Wiper Assembly (Pre-fitted)
3. Wrench
4. Wear Gauge

Note : Roller Assembly is compatible with 27 PDHD, 20 PDHD, and SDHD models.

(All the parts are interchangeable with Varco 27HDP, 20HDP, or HDS models, as well as other Kelly bushings compliant with API-7K standards)



Square Drive Kelly Bushing
Figure No. 19

Optional Pin Lock Assembly

The Optional Drive Pin Lock Assembly secures the Kelly Bushing within the Master Bushing, particularly useful for offshore drilling operations employing motion compensators. These lock assemblies are specifically designed for the 27 PDHD series Bushing. To order with an assembly, simply add "L" to the part number of the unit.

For Lock Type Kelly Bushing:

Particular	P/N for 27 PDHD Model	Identical Varco P/N
Lock Assembly	2721	3695
Drive Pin	2721-A	3697
Locking Pin	2721-B	3698
Eccentric Pin	2721-C	3696
Drive Pin Washer	2721-D	1506

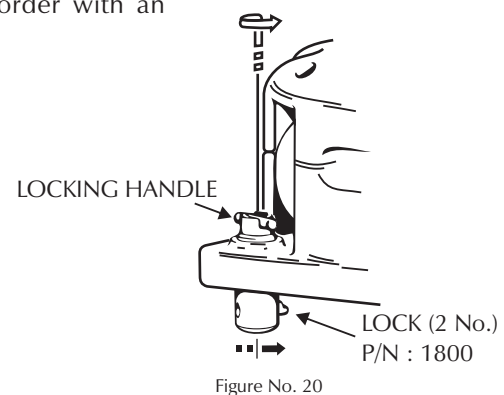

Kelly Bushing 27PDHD, 20PDHD & SDHD Complete:

Kelly Size / Type	Heavy Duty Roller Kelly Bushing				Roller Assembly Complete*	
	27 PDHD Complete Kelly Bushing		20 PDHD Complete Kelly Bushing	SDHD Complete Kelly Bushing	ABI P/N	Identical VARCO P/N
	ABI P/N	Identical VARCO P/N				
3" Hex	2701-P	3650-30	2001-P	2701-S	2101	3667
3.1/2" Hex	2702-P	3650-35	2002-P	2702-S	2102	3668
4.1/4" Hex	2703-P	3650-42	2003-P	2703-S	2103	3669
5.1/4" Hex	2704-P	3650-52	2004-P	2704-S	2104	3672
6" Hex	2705-P	3650-60	2005-P	2705-S	2105	3673
3" Sq.	2706-P	3651-30	2006-P	2706-S	2106	3660
3.1/2" Sq.	2721-P	3651-35	2011-P	2711-S	2110	3661
4.1/4" Sq.	2707-P	3651-42	2007-P	2707-S	2107	3662
5.1/4" Sq.	2708-P	3651-52	2008-P	2708-S	2108	3665
6" Sq.	2709-P	3651-60	2009-P	2709-S	2109	3666

*The Roller Assembly comprises Flat/V-roller (1 No.), Roller Pin (1 No.), Bearing (1 No.), and Thrust Washer (2 No.).

Part List of Kelly Bushing:

S. No.	Description	Qty. Per Unit	27 PDHD		20 PDHD	SDHD
			ABI P/N	Identical VARCO P/N		
1.	Kelly Bushing Body less Roller Assembly	1 No.	2710-P	3653	2010-P	2710-S
2.	Hold Down Bolt	4 No.	2711	13501	2711	2711
3.	Hold Down Bolt Lock Screw	4 No.	2711-A	50110-8-S	2711-A	2711-A
4.	Nut for Hold Down Bolt	4 No.	2712	1208	2712	2712
5.	Lock Washer for Nut	4 No.	2713	51110-C	2713	2713
6.	Drive Pin with Washer	4 No.	2714	1605	2714-S	-
7.	Wrench	1 No.	2715	1210	2715	2715
8.	Wiper Assembly	1 No.	2716	-	2716	2716
9.	Wiper Retainer Plate	1 No.	2716-B	1321	2716-B	2716-B
10.	Wiper Retainer Plate Screw	8 No.	2716-C	50008-10-S	2716-C	2716-C
11.	Roller Pin	4 No.	2717	3609	2717	2717
12.	Roller Bearing	4 No.	2718	1312	2718	2718
13.	Sleeve Bush	4 No.	2719	1326	2719	2719
14.	Thrust Washer	8 No.	2720	3618	2720	2720
15.	Lifting Sling (Four Hooks Type)	1 No.	2721	-	2721	2721

Individual Rollers:

Kelly size	For Hex Kelly				For Square Kelly	
	Flat Roller		V Roller		Flat Roller	
	ABI P/N	Identical Varco P/N	ABI P/N	Identical Varco P/N	ABI P/N	Identical Varco P/N
2.1/2"	2111	-	2119	-	2111-S	-
3"	2112	1338	2120	1339	2112-S	1331
3.1/2"	2113	1340	2121	1341	2113-S	1332
4.1/4"	2114	1342	2122	1343	2114-S	1333
4.1/2"	2115	1385	2123	1386	2115-S	-
5"	2116	1387	2124	1388	2116-S	-
5.1/4"	2117	1344	2125	1345	2117-S	1334
6"	2118	1346	2126	1347	2118-S	1335

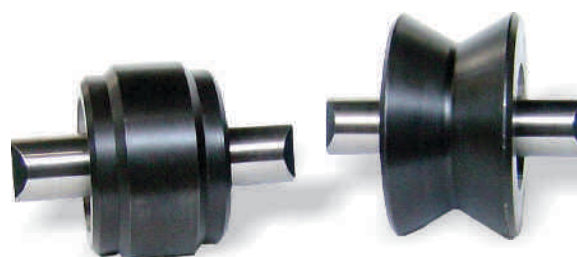

Flat & V Roller
Figure No. 21

Note:

- Items numbered 2 to 10 are pre-fitted within the Kelly Bushing Body (Item Serial No. 1).
- Items numbered 11 to 13 are pre-fitted within the complete Roller Assembly.

Kelly Bushing 17PDMD & 17SDMD Complete:

Kelly Size / Type	17 PDMD Kelly Bushing Complete	17 SDMD Kelly Bushing Complete	17 4KRVS Kelly Bushing Complete	Roller Assembly	Individual Roller for Hex	
					V Roller	Flat Roller
2.1/2" SQ	1701-P	1701-S	1701-KR	1721	1729	1737
3" SQ	1702-P	1702-S	1702-KR	1722	1730	1738
3.1/2" SQ	1703-P	1703-S	1703-KR	1723	1731	1739
4.1/4" SQ	1704-P	1704-S	1704-KR	1724	1732	1740
5.1/4" SQ	1705-P	1705-S	1705-KR	1725	1733	1741
3" HEX	1706-P	1706-S	1706-KR	1726	1734	1742
3.1/2" HEX	1707-P	1707-S	1707-KR	1727	1735	1743
4.1/4" HEX	1708-P	1708-S	1708-KR	1728	1736	1744

Part List of Kelly Bushing:

S. No.	Description	Qty. Per Unit	17 PDMD	17 SDMD	17 4KRVS
1.	Kelly Bushing Body less Roller Assembly	1 No.	1710-P	1710-S	1710-KR
2.	Hold Down Bolt	4 No.	1711	1711	1711
3.	Hold Down Bolt lock screw	4 No.	1711-A	1711-A	1711-A
4.	Nut for hold down bolt	4 No.	1712	1712	1712
5.	Lock washer for nut	4 No.	1713	1713	1713
6.	Drive pin with washer	4 No.	1714	–	1714
7.	Wrench	1 No.	1715	1715	1715
8.	Wiper assembly	1 No.	1716	1716	1716
9.	Wiper Retainer plate	1 No.	1716-B	1716-B	1716-B
10.	Wiper Retainer plate screw	8 No.	1716-C	1716-C	1716-C
11.	Roller Pin	4 No.	1717	1717	1717
12.	Roller Bearing	4 No.	1718	1718	1718
13.	Sleeve Bush	4 No.	1719	1719	1719
14.	Thrust Washer	8 No.	1720	1720	1720

Note:

- Item No. 2 to 10 are fitted in Kelly Bushing Body. (Item S.No. 1)
- Item No. 11 to 13 are fitted in Roller Assembly Complete.

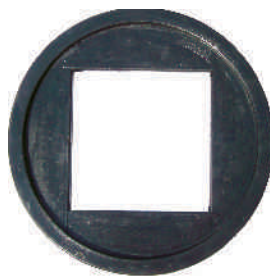

Wipers
Figure No. 22

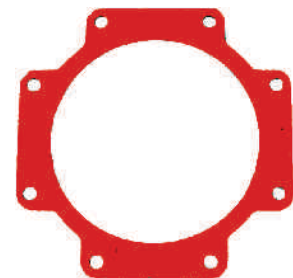

Wiper Retainer Plate
Figure No. 23

Kelly Wiper Assembly

Part List for 27" & 20" Kelly Bushing:

Kelly Size	For Square		For Hex	
	ABI P/N	Identical Varco P/N	ABI P/N	Identical Varco P/N
2.1/2"	2151	–	2159	–
3"	2152	12100	2160	12107
3.1/2"	2153	12101	2161	12108
4.1/4"	2154	12102	2162	12109
4.1/2"	2155	–	2163	–
5"	2156	–	2164	12110
5.1/4"	2157	12103	2165	12111
6"	2158	12104	2166	12112

Kelly Wiper Assembly

Part List for 17" Kelly Bushing:

Kelly Size	For Hex Kelly	For Square Kelly
2.1/2"	–	17545-S
3"	17546-H	17546-S
3.1/2"	17547-H	17547-S
4.1/4"	17548-H	17548-S
5.1/4"	–	17549-S

MANUAL TONGS

Autobahn Industries is an API Approved manufacturer of Manual Tongs, holding a valid API-7K License. These Manual Tongs are specifically designed for making up and breaking connections of tubular, ranging from lightweight Tubing Pipes to heavy Drill Pipes or Drill Collar Pipes. The versatility of our Manual Tongs allows for easy assembly for either making-up or break-out simply by removing the hanger and turning the complete Tong over.

Manufactured in strict compliance with the latest edition of API-7K Specifications, we ensure that our tongs have superior quality through rigorous testing in our in-house facilities. Each Manual Tong, along with its jaws, undergoes proof loading testing before being supplied to our customers.

Our dedication to quality spans every stage of production, ensuring that only the finest Manual Tongs reach our users.

We offer four types of Manual Tongs to cover a wide range of pipes, varying from 2.3/8" to 21" in size and torque capacities from 16,000 to 100,000 ft-lbs. These are:

1. Manual Tong 16,000 Ft-lbs - ABMT 16
2. Manual Tong 35,000 Ft-lbs - ABMT 35
3. Manual Tong 65,000 Ft-lbs - ABMT 65
4. Manual Tong 100,000 Ft-lbs - ABMT 100

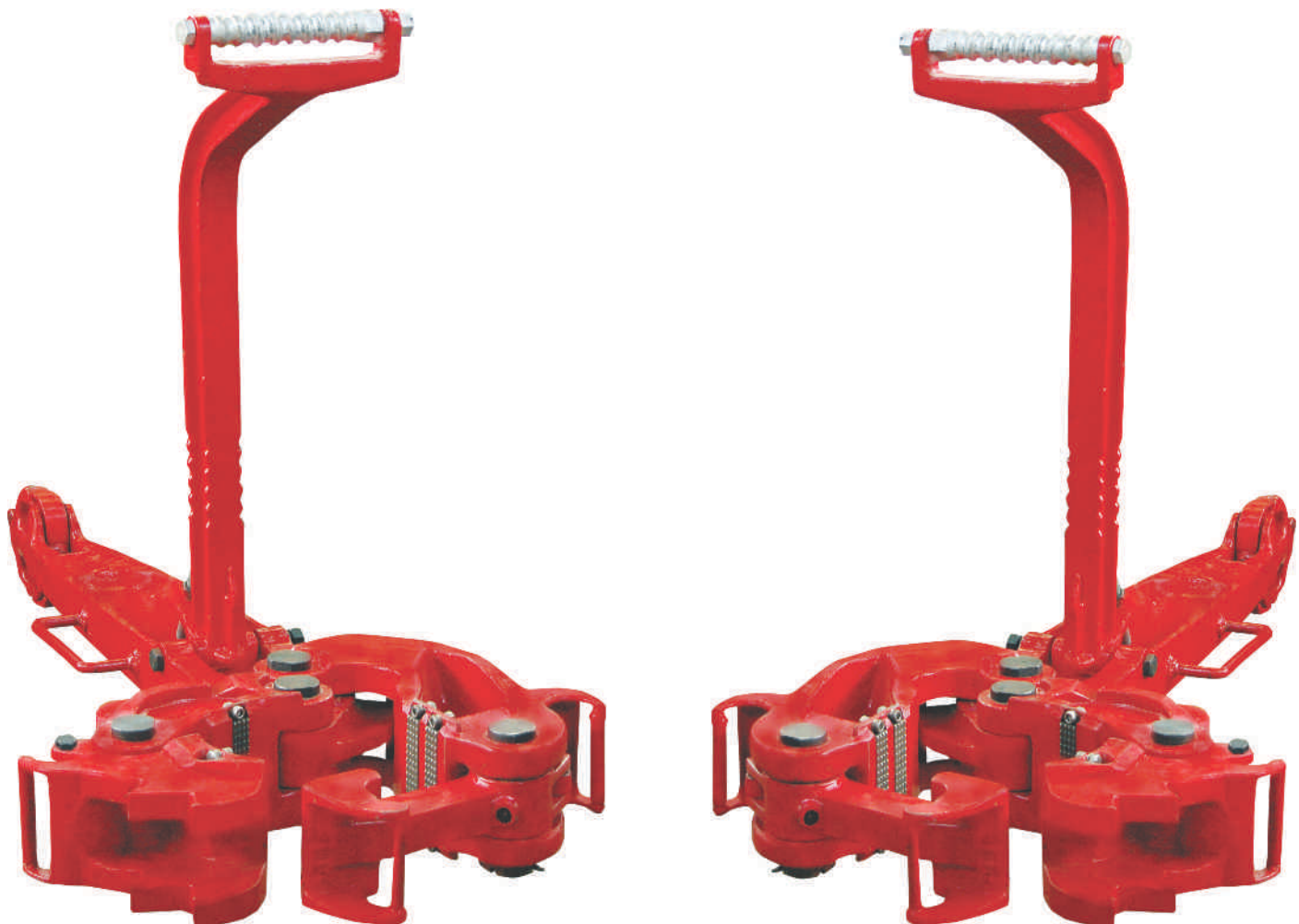

Manual Tongs
Figure No. 24

MANUAL TONG - 16000 Ft-lbs Model: ABMT-16

The Manual Tong ABMT-16 is engineered to handle tubular sizes ranging from 2.3/8" to 7", with a torque capacity of up to 16,000 Ft-Lbs.

Part List of ABMT-16:

S. No.	Description	P/N
1.	Lever Assembly	MT-1601
2.	Hanger Assembly	MT-1602
3.	Long Jaw Assembly	MT-1603
4.	Latch Assembly	MT-1604
5.	Short Jaw Assembly	MT-1605
6.	Lug Jaw Assembly (Range 2.3/8"-3.1/2")	MT-1606
7.	Lug Jaw Assembly (Range 3.1/2"-5.1/2")	MT-1607
8.	Lug Jaw Assembly (Range 4.3/4"-6.1/4")	MT-1608
9.	Lug Jaw Assembly (Range 5.3/4"-7")	MT-1609
10.	Hinge Pin w/Nut & Cotter Pin	MT-1603-2
11.	Tong Die (Blue Diamond/Pyramid)	MT-1610-B/ MT-1610-P
12.	Snub Line Saver / U Clamp Style Pull Line	MT-1611

MANUAL TONG - 35000 Ft-lbs Model: ABMT-35

The Manual Tong ABMT-35 is engineered to handle tubular sizes ranging from 2.3/8" to 10.3/4", with a torque capacity of up to 35,000 Ft-Lbs.

Part List of ABMT-35:

S. No.	Description	P/N
1.	Lever Assembly	MT-3501
2.	Hanger Assembly	MT-3502
3.	Long Jaw Assembly	MT-3503
4.	Latch Assembly	MT-3504
5.	Short Jaw Assembly (Range 2.3/8"-7")	MT-3505
6.	Short Jaw Assembly (Range 7"-10.3/4")	MT-3506
7.	Lug Jaw Assembly (Range 2.3/8"-3.668")	MT-3507
8.	Lug Jaw Assembly (Range 2.7/8"-4.1/4")	MT-3508
9.	Lug Jaw Assembly (Range 3.1/2"-5.1/4")	MT-3509
10.	Lug Jaw Assembly (Range 5.1/4"-7")	MT-3510
11.	Lug Jaw Assembly (Range 7"-85/8")*	MT-3511
12.	Lug Jaw Assembly (Range 9.5/8"-10.3/4")*	MT-3512
13.	Hinge Jaw Assembly (Range 7"-8.5/8")	MT-3513
14.	Hinge Jaw Assembly (Range 9.5/8"-10.3/4")	MT-3514
15.	Hinge Pin w/nut, Retaining Pin & Cotter Pin	MT-3503-2
16.	Tong Die (Blue Diamond/Pyramid)	MT-3515-B / MT-3515-P
17.	Snub Line Saver / U Clamp Style Pull Line	MT-3516

Note: *Also requires the Hinge Jaw Assembly.

MANUAL TONG - 65000 Ft-lbs Model: ABMT-65

The Manual Tong ABMT-65 is engineered to handle tubular sizes ranging from 3.1/2" to 17", with a torque capacity of up to 65,000 Ft-Lbs.

Part List of ABMT-65:

S. No.	Description	P/N
1.	Lever Assembly	MT-6550
2.	Hanger Assembly	MT-6553
3.	Long Jaw Assembly	MT-6558
4.	Short Jaw Assembly	MT-6562
5.	Latch Assembly	MT-6564
6.	Lug Jaw Assembly (Range 3.1/2"-8.1/4")	MT-6568
7.	Lug Jaw Assembly (Range 8"-11.1/4")*	MT-6569
8.	Lug Jaw Assembly (Range 11.3/4"-14.3/8")*	MT-6570
9.	Lug Jaw Assembly (Range 16"-17")*	MT-6571
10.	Hinge Jaw Assembly (Range 8"-17")	MT-6572
11.	Hinge Pin w/nut & Cotter Pin	MT-6567
12.	Tong Die	MT-6559
13.	Snub Line Saver / U Clamp Style Pull Line	MT-6575

Note: *Also requires the Hinge Jaw Assembly.

MANUAL TONG - 100000 Ft-lbs Model: ABMT-100

The Manual Tong ABMT-100 is engineered to handle tubular sizes ranging from 4" to 17", with a torque capacity of up to 100000 Ft-Lbs.

Part List of ABMT-100:

S. No.	Description	P/N
1.	Lever Assembly	MT-10001
2.	Hanger Assembly	MT-10002
3.	Long Jaw Assembly	MT-10003
4.	Latch Assembly	MT-10004
5.	Short Jaw Assembly	MT-10005
6.	Lug Jaw Assembly (Range 4"-8.1/2")	MT-10006
7.	Lug Jaw Assembly (Range 8.1/2"-12")*	MT-10007
8.	Lug Jaw Assembly (Range 12"-15")*	MT-10008
9.	Lug Jaw Assembly (Range 15.3/4")*	MT-10009
10.	Lug Jaw Assembly (Range 16"-17")*	MT-10010
11.	Hinge Jaw Assembly (Range 8.1/2"-17")	MT-10011
12.	Hinge Pin & Nut w/cotter Pin	MT-10003-2
13.	Tong Die (Blue Diamond/Pyramid)	MT-10012-B/ MT-10012-P
14.	Snub Line Saver / U Clamp Style Pull Line	MT-10013

Note: *Also requires the Hinge Jaw Assembly.

MANUAL CASING TONG

The Manual Casing Tong is manufactured following API-7K specifications and is specifically designed to assemble and disassemble connections ranging from 13.3/8" to 36", by extending the required hinge jaws as per the table for Casing Head Assemblies.

This tong is engineered to handle torque capacities of up to 26,000 Ft-lbs. It boasts excellent durability, crafted from high-grade alloy steel that undergoes rigorous testing as per API - 7K specification to ensure reliability and performance.

Part List of Manual Casing Tong:

S. No.	Description	Identification No.	P/N
1.	Lever Assembly	L1	CT-3501
2.	Hanger Assembly	-	CT-3502
3.	Long Jaw Assembly	L2	CT-3503
4.	Short Jaw Assembly	L3	CT-3504
5.	Latch Jaw Assembly	L4	CT-3505
6.	Latch Assembly	L5	CT-3506
7.	Lug Jaw Assembly	L6	CT-3507
8.	Hinge Jaw Assembly	L7	CT-3508
9.	Hinge Jaw Assembly	L8	CT-3509
10.	Hinge Jaw Assembly	L9	CT-3510
11.	Hinge Pin w/Nut & Cotter Pin for L2, L3 & L5	-	CT-3503-2
12.	Hinge Pin w/ Two Cotter Pin for L4, L6, L7, L8 & L9	-	CT-3505-2
13.	Tong Die	-	MT-1610-P

Table for Casing Head Assemblies:

Fig. No. At Page No. 13	Pipe Range (Inches)	Type and No. of Hinge Jaws to be used		
		L7	L8	L9
A	13.3/8-14.1/2	-	1 No.	1 No.
B	14.1/2-16	1 No.	1 No.	-
C	16-17.1/2	-	1 No.	2 No.
D	17.1/2-19	1 No.	1 No.	1 No.
E	19-20	2 No.	1 No.	-
F	20-21.1/2	1 No.	1 No.	2 No.
G	21.1/2-23	2 No.	1 No.	1 No.
H	24-25.1/2	2 No.	1 No.	2 No.
I	25.1/2-27	3 No.	1 No.	1 No.
J	27-28.1/2	4 No.	1 No.	-
K	28.1/2-30	3 No.	3 No.	-
L	30-31.1/2	4 No.	2 No.	-
M	31.1/2-33	3 No.	2 No.	2 No.
N	33-34.1/2	2 No.	2 No.	4 No.
O	34.1/2-36	2 No.	5 No.	1 No.

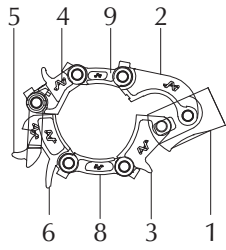

Fig A, 13.3/8"-14 1/2"

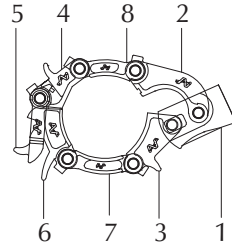

Fig B, 14.1/2"-16"

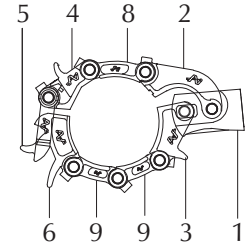

Fig C, 16"-17.1/2"

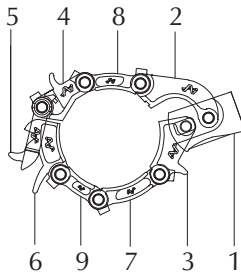

Fig D, 17.1/2"-19"

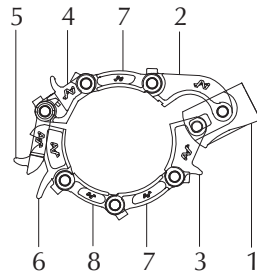

Fig E, 19"-20"

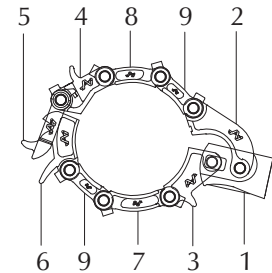

Fig F, 20"-21.1/2"

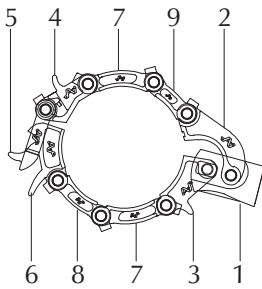

Fig G, 21.1/2"-23"

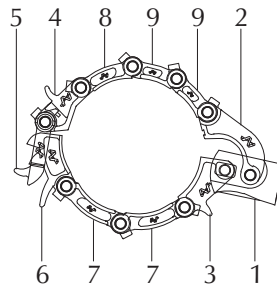

Fig H, 24"-25.1/2"

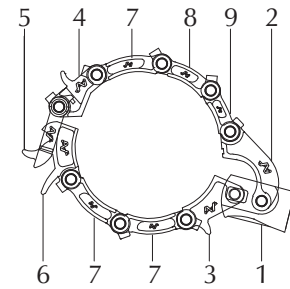

Fig I, 25.1/2"-27"

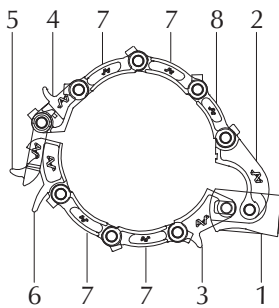

Fig J, 27"-28.1/2"

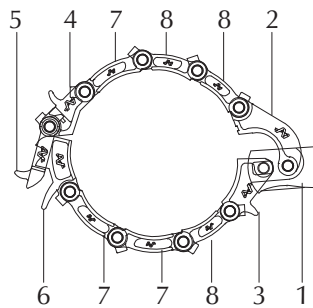

Fig K, 28.1/2"-30"

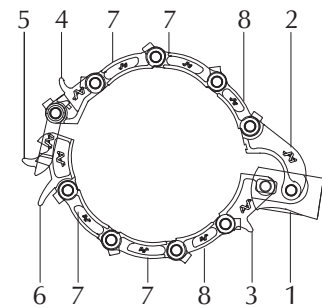

Fig L, 30"-31.1/2"

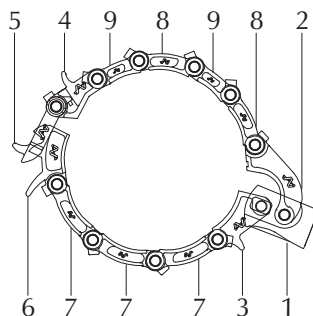

Fig M, 31.1/2"-33"

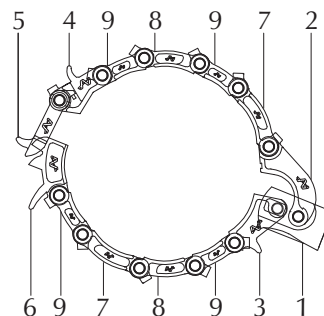

Fig N, 33"-34.1/2"

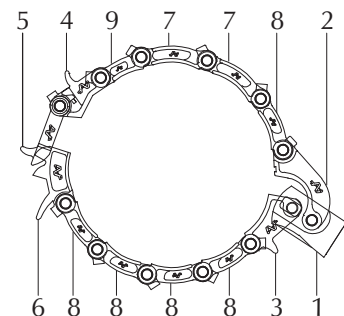

Fig O, 34.1/2"-36"

PNEUMATIC TUBING SPIDERS

Autobahn Industries is an API-approved manufacturer of Spiders, holding a valid API-7K License. Our Spiders are meticulously crafted in strict compliance with the latest edition of API-7K Specifications.

Tubing Spiders offer the flexibility of being operated pneumatically or hydraulically, making them widely utilized in the tripping process. They can be conveniently operated using a foot remote control valve, facilitating the lifting and setting off of Manual Slips.

Manufactured from high-grade alloy and heat-treated for prolonged product life and superior quality, our Spiders ensure durability and reliability. The Slip Inserts are meticulously designed to firmly grip tubulars complete with a 360° hold.

Available in three models based on different load ratings and gripping sizes - Model C, CHD, and E.

Optional Accessories: Adapter Plate.

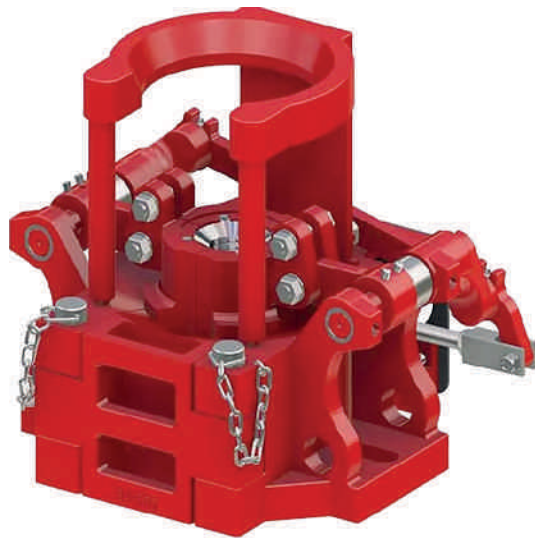

Pneumatic Tubing Spiders
Figure No. 25

Various type of Tubing Spider:

Model	Rated Capacity (up to)	Slip Body Size (In Inch)	OD of tubular (In Inch)
AB-PTS-C	100 Ton	3.1/2	1.315-3.1/2
		4.1/2	3.1/2-4.1/2
		4.3/4 (Integral)	4.3/4
		5 (Integral)	5
		5.1/2 (Integral)	5.1/2
AB-PTS-CHD	125 Ton	3.1/2	1.315-3.1/2
		4.1/2	3.1/2-4.1/2
		4.3/4 (Integral)	4.3/4
		5 (Integral)	5
		5.1/2 (Integral)	5.1/2
AB-PTS-E	200 Ton	3.1/2	2.3/8 to 3.1/2
		5.1/2	4 to 5.1/2
		7	5.1/2 to 7
		7.5/8 (Integral)	7.5/8
		8.5/8 (Integral)	8.5/8

Note: Hydraulic Spiders are also available on request.

Part List of Inserts:

Slip Body Size (Inches)	Pipe Size (OD Inches)	Insert Set* Part No.
3.1/2	1.315	1101
	1.660	1102
	1.900	1103
	2.060	1104
	2.3/8	1105
	2.7/8	1106
	3.5	1107
4.1/2	3.5	1108
	4	1109
	4.5	1110
5.1/2	4	1111
	4.5	1112
	5	1113
	5.1/2	1114
7	5.1/2	1115
	6.5/8	1116
	7	1117

*Set Consists of 4 No. of Dies.

Adapter Plate for Pneumatic Spider (Optional)

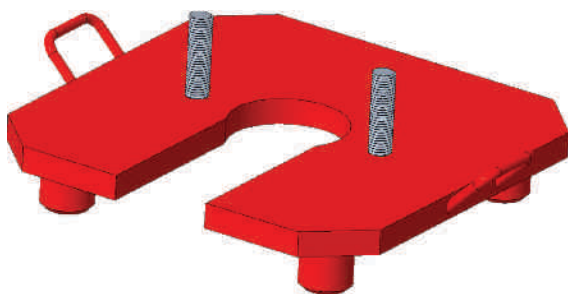

For Pin Drive Master Bushing
Figure No. 26

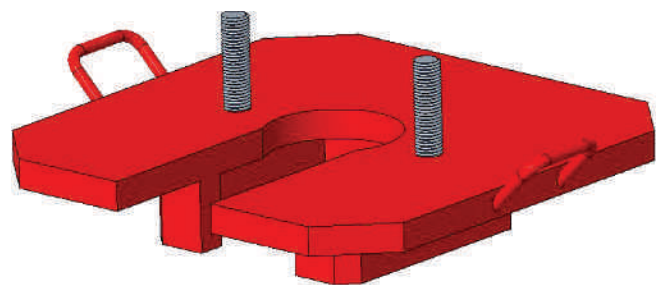

For Square Drive Master Bushing
Figure No. 27

Master Bushing Size/Type	17.1/2"	20.1/2"	27.1/2"	37.1/2"
Square Drive	1755-PTS-SQ	2055-PTS-SQ	2755-PTS-SQ	–
Pin Drive	1755-PTS	2055-PTS	2755-PTS	3717-PTS

ROTARY SLIPS

Autobahn Industries is an API-approved manufacturer of Rotary Slips, holding a valid API-7K License for the past 23 years. Our Rotary Slips, or Drill Pipe Slips, are engineered to safely hold the drill string weight while providing a full range of operations. They play a critical role in transferring the load from the elevators to the Rotary Table.

Autobahn Industries' slips are designed to withstand substantial dynamic loading without catastrophic failures, such as slip-toe damage, which could endanger rig crews and slow down operations. Designed for use in standard API Insert Bowls/Slip Bowls, our slips feature an API taper of 4 inches per foot on the diameter. The excellent design ensures that the load is evenly distributed throughout the length of the slips, preventing bottleneck damage to drill pipes. Made from superior, high-quality materials, our Rotary Slips offer great strength and reduced wear and tear, resulting in a longer lifespan.

Manufactured in strict accordance with the latest edition of API-7K Specifications, our Slips meet and exceed quality standards and are supplied with the API-7K Monogram.

We offer three models of Rotary Slip/Drill Pipe Slip:

1. Rotary Slip Short (SDS) – Load Rating: 100 Tons
2. Rotary Slip Medium (SDML) – Load Rating: 150 Tons
3. Rotary Slip Large (SDXL) – Load Rating: 250 Tons

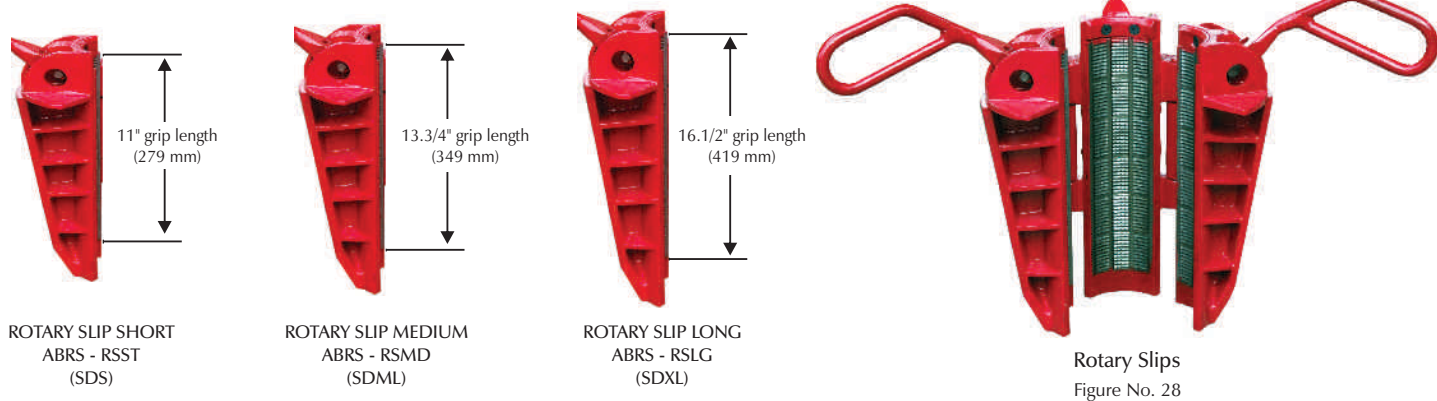

Part List of ABRS - RSST Short Rotary Slips (SDS):

Slip Body Size (Inches)	3.1/2			4.1/2		
	API Pipe Sizes (OD in Inches)	2.3/8	2.7/8	3.1/2	3.1/2	4
Slip Complete w/Insert Part No.	5101	5102	5103	5104	5105	5106
Weight Complete with Inserts	61 Kg.	59 Kg.	56 Kg.	73 Kg.	70 Kg.	66 Kg.
Insert Part No.	5160-24	5161-24	5162-24	5163-36	5164-36	5165-36

Slip Body Size (Inches)	3.1/2		4.1/2		
	Description	Qty. Per Unit	Part No.	Qty. Per Unit	Part No.
	Slip Segment - Right	1 No.	5107	1 No.	5118
	Slip Segment - Center	1 No.	5108	1 No.	5119
	Slip Segment - Left	1 No.	5109	1 No.	5120
	Handle - Right	1 No.	5110	1 No.	5110
	Handle - Center	1 No.	5111	1 No.	5111
	Handle - Left	1 No.	5112	1 No.	5112
	Handle Pin w/Washer & Cotter Pin	3 No.	5113	3 No.	5113
	Hinge Pin w/Cotter Pin	2 No.	5114	2 No.	5114
	Retaining Ring	3 No.	5115	3 No.	5115
	Insert Retaining Screw w/Washer	6 No.	5116	6 No.	5116
	Kit - (Hex Nuts, Bolts & Wrench)	1 No.	5117	1 No.	5117

Part List of ABRS-RSMD Medium Rotary Slips (SDML):

Slip Body Size (Inches)	3.1/2			4.1/2		
API Pipe Sizes (OD Inches)	2.3/8	2.7/8	3.1/2	3.1/2	4	4.1/2
Slip Complete w/Insert Part No.	5121	5122	5123	5124	5125	5126
Weight Complete with Inserts	84 Kg.	84 Kg.	81.5 Kg.	94 Kg.	91 Kg.	86 Kg.
Insert Part No.	5160-30	5161-30	5162-30	5163-45	5164-45	5165-45

Slip Body Size (Inches)	5			5.1/2		
API Pipe Sizes (OD Inches)	4	4.1/2	5	4.1/2	5	5.1/2
Slip Complete w/Insert Part No.	5127	5128	5129	5130	5131	5132
Weight Complete with Inserts	92.5 Kg.	89 Kg.	84 Kg.	91 Kg.	84 Kg.	82.5 Kg.
Insert Part No.	5168-45A	5166-45	5167-45	5168-45B	5169-45	5170-45

Slip Body Size (Inches)	3.1/2		4.1/2		5		5.1/2	
Description	Qty. Per Unit	P/N	Qty. Per Unit	P/N	Qty. Per Unit	P/N	Qty. Per Unit	P/N
Slip Segment - Right	1 No.	5133	1 No.	5137	1 No.	5141	1 No.	5145
Slip Segment - Center	1 No.	5134	1 No.	5138	1 No.	5142	1 No.	5146
Slip Segment - Left	1 No.	5135	1 No.	5139	1 No.	5143	1 No.	5147
Handle - Right	1 No.	5110	1 No.	5110	1 No.	5110	1 No.	5110
Handle - Center	1 No.	5111	1 No.	5111	1 No.	5111	1 No.	5111
Handle - Left	1 No.	5112	1 No.	5112	1 No.	5112	1 No.	5112
Handle Pin w/Washer & Cotter Pin	3 No.	5113	3 No.	5113	3 No.	5113	3 No.	5113
Hinge Pin w/Cotter Pin	2 No.	5136	2 No.	5136	2 No.	5136	2 No.	5136
Retaining Ring	3 No.	5140	3 No.	5140	3 No.	5144	3 No.	5148
Insert Retaining Screw w/Washer	6 No.	5116	6 No.	5116	6 No.	5116	6 No.	5116
Kit - (Hex Nuts, Bolts & Wrench)	1 No.	5117	1 No.	5117	1 No.	5117	1 No.	5117

Part List of ABRS - RSLG Extra Long Rotary Slips (SDXL):

Slip Body Size (Inches)	4.1/2			5		
API Pipe Sizes (OD Inches)	3.1/2	4	4.1/2	4	4.1/2	5
Slip Complete w/Insert Part No.	5152	5153	5154	5155	5156	5157
Weight Complete with Inserts	104 Kg.	99 Kg.	93 Kg.	108 Kg.	103 Kg.	97 Kg.
Insert Part No.	5163-54	5164-54	5165-54	5168-54A	5166-54	5167-54

Slip Body Size (Inches)	5.1/2			7		
API Pipe Sizes (OD Inches)	4.1/2	5	5.1/2	5.7/8	6.5/8	7
Slip Complete w/Insert Part No.	5158	5159	5180	5198	5199	5200
Weight Complete with Inserts	106 Kg.	102 Kg.	95 Kg.	120 Kg.	110 Kg.	105 Kg.
Insert Part No.	5168-54B	5169-54	5170-54	5171-72	5172-72	5173-72

Slip Body Size (Inches)	4.1/2		5		5.1/2		7	
Description	Qty. Per Unit	P/N	Qty. Per Unit	P/N	Qty. Per Unit	P/N	Qty. Per Unit	P/N
Slip Segment - Right	1 No.	5185	1 No.	5188	1 No.	5191	1 No.	5194
Slip Segment - Center	1 No.	5186	1 No.	5189	1 No.	5192	1 No.	5195
Slip Segment - Left	1 No.	5187	1 No.	5190	1 No.	5193	1 No.	5196
Handle - Right	1 No.	5110	1 No.	5110	1 No.	5110	1 No.	5110
Handle - Center	1 No.	5111	1 No.	5111	1 No.	5111	1 No.	5111
Handle - Left	1 No.	5112	1 No.	5112	1 No.	5112	1 No.	5112
Handle Pin w/Washer & Cotter Pin	3 No.	5113	3 No.	5113	3 No.	5113	3 No.	5113
Hinge Pin w/Cotter Pin	2 No.	5184	2 No.	5184	2 No.	5184	2 No.	5184
Retaining Ring	3 No.	5140	3 No.	5144	3 No.	5148	3 No.	5149
Insert Retaining Screw w/Washer	6 No.	5116	6 No.	5116	6 No.	5116	6 No.	5116
Kit - (Hex Nuts, Bolts & Wrench)	1 No.	5117	1 No.	5117	1 No.	5117	1 No.	5117

DRILL COLLAR SLIPS

Featuring enhanced wraparound insert designs, Autobahn's Manual Drill Collar Slips prevent bottlenecking and gouging damage while providing superior contact and vertical load distribution for drill pipes. Each slip segment is cast with an extra-long back, offering maximum support to the circular button-gripping elements. The multi-segmented drill collar slip is manufactured from heat-treated alloy steel, ensuring exceptional wear resistance and maximum load-carrying capacity. Strong and balanced, these slips are designed to minimize crew fatigue and maintenance, providing extended performance.

Our slips are meticulously designed and manufactured in accordance with API-7K Specifications. Drill Collar Slips are available in three types, accommodating all popular drill collar sizes ranging from 3" OD to 14" OD.

Description	Slip Type, Size and Range (OD, inches)				
	ABDCS-S		ABDCS-R		ABDCS-L
	3-4	4-4.7/8	4.1/2-6	5.1/2-7	6.3/4-8.1/4
P/N, Slip Complete w/Circular Buttons	5201	5202	5203	5204	5205
Weight Complete with Inserts	47 Kg.	47 Kg.	54 Kg.	51 Kg.	70 Kg.
Total Number of Segments	7 No.	7 No.	9 No.	9 No.	11 No.
Total Number of Hinge Pins	6 No.	6 No.	8 No.	8 No.	10 No.
Insert Bowl	Bowl No. 3				

Description	Slip Type, Size and Range (OD, inches)				
	ABDCS-L				
	8-9.1/2	8.1/2-10	9.1/4-11.1/4*	11-12.3/4*	12-14*
P/N, Slip Complete w/Circular Buttons	5206	5207	5208	5209	5210
Weight Complete with Inserts	78 Kg.	84 Kg.	90 Kg.	96 Kg.	94 Kg.
Total Number of Segments	12 No.	13 No.	14 No.	17 No.	17 No.
Total Number of Hinge Pins	11 No.	12 No.	13 No.	16 No.	16 No.
Insert Bowl	Bowl No. 3	Bowl No. 2		Bowl No. 1	

Note: *Is to be supplied with 4 No. handles.

Part List of Drill Collar Slips:

Description	ABDCS-S P/N	ABDCS-R P/N	ABDCS-L P/N
Segment - Right End	5212	5237	5241
Segment - Left End	5213	5238	5242
Segment - Intermediate	5214	5239	5243
Hinge Pin w/Cotter Pin	5215	5240	5244
Handle Pin w/Washer & Cotter Pin	5216	5216	5216
Handle for Right & Left End Segment	5217	5217	5217
Handle for Intermediate Segment	5218	5218	5218
Retaining Cotter Pin	5235	5235	5235
Retaining Screw w/lock washer	5236	5236	5236

Part No. for Circular Button:

Slip Type	Slip Size Drill Collar Range (Inches)	P/N	Qty. Per Unit
Short	3-4	5228-49	49 No.
	4-4.7/8	5220-49	49 No.
Regular	4.1/2-6	5228-63	63 No.
	5.1/2-7	5220-63	63 No.
Long	6.3/4-8.1/4	5230-88	88 No.
	8-9.1/2	5230-96	96 No.
	8.1/2-10	5227-104	104 No.
	9.1/4-11.1/4	5230-112	112 No.
	11-12.3/4	5225-136	136 No.
	12-14	5230-136	136 No.

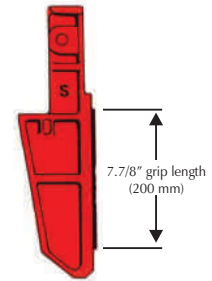

DRILL COLLAR SHORT (ABDCS-S)

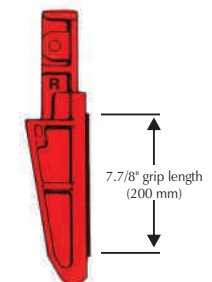

DRILL COLLAR REGULAR (ABDCS-R)

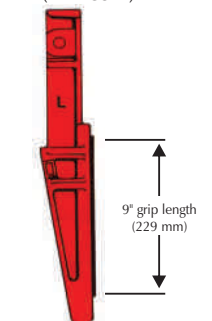

DRILL COLLAR LONG (ABDCS-L)



Drill Collar Slips
Figure No. 29

CASING SLIPS

Today's deeper drilling requires long and heavy casing strings, and Autobahn's Casing Slips are designed to handle any casing job with ease. Our CMS slips are made from castings and reinforced to withstand severe service conditions. The multi-segment design ensures a self-centered, full wraparound grip that prevents damage to the casing. This design allows for handling casing sizes from 5" to 30" OD by increasing or decreasing the number of segments and dressing the slip with appropriately sized inserts.

Casing Slips have a grip length of 13.1/2" (343mm) and an API taper of 4 inches per foot on the diameter. They are manufactured strictly in accordance with the latest edition of API-7K Specifications.



Casing Slips
Figure No. 30

Description	Casing Size (OD, inches)							
	5	5.1/2	6.5/8	7	7.5/8	8.5/8	9	9.5/8*
P/N, Slip Complete w/Circular Buttons	5300	5300A	5301	5302	5303	5304	5304A	5305
Weight Complete with Inserts	89 Kg.	88 Kg.	89 Kg.	84 Kg.	76 Kg.	83 Kg.	88 Kg.	88 Kg.
Total Number of Segments	11 No.	11 No.	12 No.	12 No.	12 No.	13 No.	14 No.	14 No.
Total Number of Hinge Pins	10 No.	10 No.	11 No.	11 No.	11 No.	12 No.	13 No.	13 No.

Description	Casing Size (OD, inches)							
	9.7/8 & 10*	10.3/4*	11.3/4*	12.3/4*	13.3/8*	14*	16*	16.3/4*
P/N, Slip Complete w/Circular Buttons	5305A	5306	5307	5307A	5308	5308A	5309	5309A
Weight Complete with Inserts	107 Kg.	95 Kg.	118 Kg.	129 Kg.	112 Kg.	153 Kg.	140 Kg.	173 Kg.
Total Number of Segments	14 No.	15 No.	17 No.	17 No.	18 No.	19 No.	21 No.	22 No.
Total Number of Hinge Pins	13 No.	14 No.	16 No.	16 No.	17 No.	18 No.	20 No.	21 No.

Description	Casing Size (OD, inches)							
	18*	18.5/8*	20*	22*	24*	26*	28*	30*
P/N, Slip Complete w/Circular Buttons	5309B	5310	5311	5311A	5312	5313	5313A	5314
Weight Complete with Inserts	199 Kg.	167 Kg.	175 Kg.	205 Kg.	202 Kg.	222 Kg.	249 Kg.	249 Kg.
Total Number of Segments	25 No.	25 No.	26 No.	28 No.	30 No.	33 No.	37 No.	37 No.
Total Number of Hinge Pins	24 No.	24 No.	25 No.	27 No.	29 No.	32 No.	36 No.	36 No.

Note: *Is to be supplied with 04 No. handles.

CP-S Conductor Pipe Slip:

Description	Casing Size (OD, inches)			
	24	26	30	36
P/N, Slip Complete w/Circular Buttons	5341	5342	5343	5344
Weight Complete with Inserts	125 Kg.	134 Kg.	145 Kg.	164 Kg.
Total Number of Segments	13 No.	14 No.	16 No.	18 No.
Total Number of Hinge Pins	24 No.	26 No.	30 No.	34 No.

Part List of Casing Slips:

Description	P/N
Segment - Right End	5316
Segment - Left End	5317
Segment - Intermediate	5318
Hinge Pin w/Cotter Pin	5319
Handle Pin w/Washer & Cotter Pin	5320
Handle for Right & Left End Segment	5321
Handle for Intermediate Segments	5322
Retaining Screw w/Lock Washer	5323

FLEXIBLE HANDLES

1. Flexible Handles can be easily fitted onto slips without requiring any modification.
2. Flexible Handles offer increased safety during use and are more durable.
3. They help reduce the likelihood of bending and breaking.
4. Flexible Handles minimize the risk of injury to the crew.



Part No. for Circular Buttons:

Type	Slips		Circular Buttons	
	Casing Sizes (Inches)	P/N	Qty. Per Unit	
CMS-XL	5	5221-132	132 No.	
	5.1/2	5222-132	132 No.	
	6.5/8	5228-144	144 No.	
	7	5219-144	144 No.	
	7.5/8	5230-144	144 No.	
	8.5/8	5230-156	156 No.	
	9	5229-168	168 No.	
	9.5/8	5230-168	168 No.	
	9.7/8 & 10	5230-168	168 No.	
	10.3/4	5230-180	180 No.	
EXTRA	11.3/4	5227-204	204 No.	
	12.3/4	5231-216	216 No.	
LONG	13.3/8	5230-216	216 No.	
	14	5228-228	228 No.	
	16	5231-252	252 No.	
	16.3/4	5231-264	264 No.	
	18	5228-300	300 No.	
	18.5/8	5226-300	300 No.	
	20	5231-312	312 No.	
	22	5230-336	336 No.	
	24	5231-360	360 No.	
	26	5231-396	396 No.	
	28	5228-432	432 No.	
	30	5231-444	444 No.	

Description	Handle Part No.		
	For Rotary Slips	For Drill Collar Slips	For Casing Slips
Handle for Segment-Right End	5110F	5217F (R)	5321F (R)
Handle for Segment-Left End	5112F	5217F (L)	5321F (L)
Handle for Segment-Intermediate	5111F	5218F	5322F

RHS ROTARY HAND SLIPS

Autobahn Industries manufactures the RHS Rotary Hand Slip, a heavy-duty slip widely utilized in deep drilling operations. The RHS Slip features a gripping length of 16.1/2" (419mm) and an API taper of 4 inches per foot on the diameter. It is primarily used to hang off drill pipe during operations such as running in or pulling out of a hole.

The excellent design ensures that the load is evenly distributed throughout the length of the slips, preventing bottleneck damage to drill pipes. Made from superior, high-quality materials, our RHS Rotary Slip offers great strength and reduced wear and tear, resulting in a longer lifespan.

Manufactured in strict accordance with the latest edition of API-7K Specifications, our slips meet and exceed quality standards and are supplied with the API-7K Monogram.



RHS Rotary Hand Slips
Figure No. 32

Slip Body Size (Inches)	To Handle Drill Pipe Size (Inches)	Insert Bowl	Load Rating (Ton)
5	4-5	Bowl No. 3	500
6	5-6	Bowl No. 3	675
7	6-7	Bowl No. 3	750

Body Size (Inches)	Pipe Size (Inches)	Complete Unit Part No.	Insert Part No.	Qty of Inserts (Per Set)
5	5	75001	75124	24 No.
	4.875	75002	75224	24 No.
	4.75	75003	75324	24 No.
	4.625	75004	75424	24 No.
	4.5	75005	75524	24 No.
	4.375	75006	75624	24 No.
	4.25	75007	75724	24 No.
	4.125	75008	75824	24 No.
	4	75009	75924	24 No.
6	6	76001	76124	24 No.
	5.875	76002	76224	24 No.
	5.75	76003	76324	24 No.
	5.625	76004	76424	24 No.
	5.5	76005	76524	24 No.
	5.375	76006	76624	24 No.
	5.25	76007	76724	24 No.
	5.125	76008	76824	24 No.
	5	76009	76924	24 No.

Body Size (Inches)	Pipe Size (Inches)	Complete Unit Part No.	Insert Part No.	Qty of Inserts (Per Set)
7	6	77001	77124	24 No.
	6.125	77002	77224	24 No.
	6.250	77003	77324	24 No.
	6.375	77004	77424	24 No.
	6.5	77005	77524	24 No.
	6.625	77006	77624	24 No.
	6.750	77007	77724	24 No.
	6.875	77008	77824	24 No.
	7	77009	77924	24 No.

Note: RHS Rotary Hand Slips variants beyond the standard offering can be customized to meet specific customer requirements upon request.

PNEUMATIC BACKSAVER

Autobahn manufactures the Pneumatic Backsaver or Power Slip Lifter, a pneumatically operated power tool designed to lift drill pipe slips. Its purpose is to reduce personnel fatigue and minimize injuries by enabling remote operation from the driller's cabin or stand-alone control panels. Additionally, it extends the life of slips and inserts by properly setting and raising them. The Slip Lifter is compatible with Autobahn's drill pipe slips (SDS, SDML & SDXL) ranging from 2.3/8" to 7.5/8", as well as with any other API brand slips.

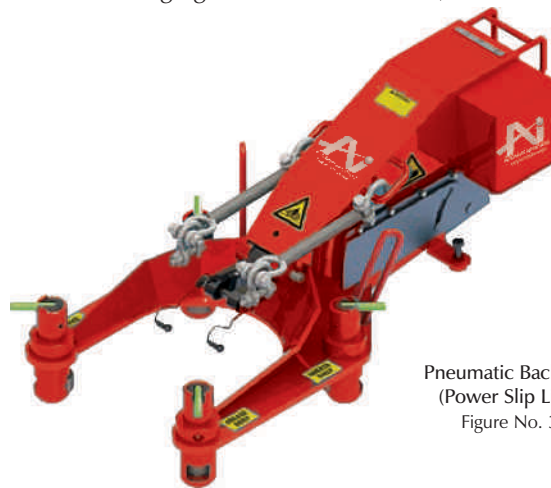

Pneumatic Backsaver
(Power Slip Lifter)
Figure No. 33

Technical Specification:

Rotary Table	17.1/2"-37.1/2" Pin drive master bushing API Pin Drive Pitch diameter 654.05 mm
Pipe Size Range	2.3/8"-7.5/8"
Operating Pressure	7 Bar (100 psi)
Type of Slip	Short(SDS), Medium(SDML) & Long(SDXL)

Note: Hydraulic Operated Backsaver is also available on request.

Type of Adapter

Pneumatic Backsaver can be used with different Adapters as per the type of Slip.

Slip Type	Part No.
Short (SDS)	SLA-01
Medium (SDML)	SLA-02
Long (SDXL)	SLA-03



Pneumatic Backsaver Adapter
Figure No. 34

HYDRAULIC POWER SLIP (Eq. to PS 500)

Model: HPS-500

Autobahn's Hydraulic Power Slip is engineered to handle long, heavy tubulars ranging from 2.3/8" to 14", with a capacity of 500 tons. They can be installed in various Rotary Tables, with adapters available for different sizes and types. The Power Slip features a central greasing system and hydraulic feedback for "Slips Up" and "Slips Down" operations.

Special Features :

1. Slip Assemblies and Insert Carriers are interchangeable with the HPS-500.
2. A single HPS-500 body can accommodate the entire range of 2.3/8" to 14" tubulars.



Hydraulic Power Slip
Figure No. 35

Technical Specification:

Maximum permissible operating load	500 short ton
Material and Production Standard	API 7K Specification
Pipe diameter	2.3/8"-14"
Rotary Table diameter	37.1/2"
Rotary Table	All Rotary Table with respective Adapter
Hydraulic Working Pressure	Min 160 bar (2321 psi), Max 210 bar (3046 psi)
Hydraulic Flow Rate	Min 18.9 L/min (5 gpm), Max 37.9 L/min (10 gpm)

S.No.	Item Description	Part No.
1.	Body	HPS-51
2.	Door Assembly	HPS-52
3.	Centring System	HPS-53
4.	Slip Assembly	HPS-55
5.	Stand Alone Control Unit For Operating Power Slip	Upon request

Insert Carrier Detail:

S.No.	Insert Carrier for Drill Pipe	Inserts Part No.	Carrier Body Size	Part No.	Load Rating (Ton)
1.	2.3/8"	HPS-5601	3.1/2"	HPS-561	250
2.	2.7/8"	HPS-5602			
3.	3.1/2"	HPS-5603			
4.	3.1/2"	HPS-5604	4.1/2"	HPS-562	350
5.	4"	HPS-5605			
6.	4.1/2"	HPS-5606			
7.	4.1/2"	HPS-5607	5.1/2"	HPS-563	500
8.	5"	HPS-5608			
9.	5.1/2"	HPS-5609			
10.	5.7/8"	HPS-5610	7"	HPS-564	500
11.	6.5/8"	HPS-5611			
12.	6.906"	HPS-5612			
13.	7"	HPS-5613			
14.	6.5/8"	HPS-5614	7.5/8"	HPS-565	500
15.	6.906"	HPS-5615			
16.	7"	HPS-5616			
17.	7.5/8"	HPS-5617			
18.	7.3/4"	HPS-5618			
S.No.	Insert Carrier for Casing Pipe				
19.	8.5/8"	HPS-5619	9.5/8"	HPS-566	500
20.	9.5/8"	HPS-5620			
21.	9.5/8"	HPS-5621	10.3/4"	HPS-567	500
22.	9.7/8"	HPS-5622			
23.	10"	HPS-5623			
24.	10.3/4"	HPS-5624	12.3/4"	HPS-568	500
25.	11.3/4"	HPS-5625			
26.	11.7/8"	HPS-5626			
27.	12.3/4"	HPS-5627	14"	HPS-569	500
28.	12.3/4"	HPS-5628			
29.	13.3/8"	HPS-5629			
30.	13.1/2"	HPS-5630			
31.	13.5/8"	HPS-5631			
32.	14"	HPS-5632			

S.No.	Insert Carrier for Drill Collar with Zip Groove				
33.	4.3/4"	HPS-5633	4.1/2"	HPS-571	150
34.	5.1/4"	HPS-5634	5.1/2"	HPS-572	150
35.	6.1/4"	HPS-5635	6.3/4"	HPS-573	150
36.	6.1/2"	HPS-5636			
37.	6.3/4"	HPS-5637			
38.	7"	HPS-5638			
39.	8"	HPS-5639	8.1/2"	HPS-574	150
40.	8.1/4"	HPS-5640			
41.	8.1/2"	HPS-5641			
42.	8.3/4"	HPS-5642			
43.	9"	HPS-5643	9.1/2"	HPS-575	150
44.	9.1/2"	HPS-5644			
45.	9.3/4"	HPS-5645			
46.	10"	HPS-5646			

Optional Accessories:

S.No.	Description	Part No.
1.	Guide Plate 5.7/8"	HPS-534
2.	Guide Plate 6.5/8"	HPS-535
3.	3-Point Lifting Rope for Slip Segment	HPS-536
4.	4-Point Lifting Rope for Hydraulic Power Slip	HPS-537
5.	Insert Carrier Lifting Tool	HPS-538
6.	Top Wear Guide	HPS-539

SPRING LOADED POWER SLIP (Eq. to PS 15)

Model: ABSPS-27

The Autobahn Spring Loaded Power Slip (ABSPS-27) is a foot-operated device designed to eliminate the manual lifting and setting of slips. It uses coil springs as a counterbalance to offset the weight of the slips when in the upper, released position. The slip can be set simply by applying pressure to the slip set ring, and released by pressing the foot pedal. This Power Slip is capable of handling drill pipes and tubing ranging from 3.1/2" to 5.1/2" in size. It is compatible with 27.1/2", 37.1/2" and 49.1/2" Rotary Tables with API standard Pin Drive Master Bushings.



Spring Loaded Power Slip
Figure No. 36

The unit consists of three major assemblies as follows:

1. Top Cover Assembly:

The Top Cover Assembly is ergonomically designed in two halves with a slip set ring. It is mounted on four slip hangers with pins for secure attachment.

2. Slip Assembly:

The Slip Assembly consists of four slip segments, each with a 16.1/2" grip length for handling tubular sizes from 3.1/2" to 5.1/2". The slips are equipped with 48 inserts, 4 insert retaining rings, and 8 Allen screws for a secure grip.

3. Bowl Assembly:

The Bowl Assembly is composed of two halves connected by a hinge pin, allowing easy installation and removal of the Power Slip from the Master Bushing. It includes four coil spring cartridges and a foot pedal for releasing the slips.

Part List of Spring Loaded Power Slip:

S. No.	P/N	Description	Qty. Per Unit
1.	SPS-28	Spring Cartridges	4 No.
2.	SPS-29	Foot Pedal	1 No.
3.	SPS-31	Slip Hangers	4 No.
4.	SPS-32	5.1/2" Slip Segment to handle 4.1/2"-5.1/2" Drill Pipe.	4 No.
5.	SPS-33	4.1/2" Slip Segment to handle 3.1/2"-4.1/2" Drill Pipe.	4 No.
6.	SPS-40	Slip Bowl	1 No.
7.	SPS-41	Top Cover	1 No.
8.	SPS-42	Brass Bush	4 No.
9.	SPS-43	Hinge Pin for Bowl	1 No.
10.	SPS-44	Hanger Top Pin	4 No.
11.	SPS-45	Hanger Bottom Pin	4 No.
12.	SPS-46	Lifting Sling (Four Hook Type)	1 No.
13.	SPS-47	Oil Seal	4 No.
14.	SPS-48	Foot Pedal Pin	1 No.
15.	5163	Inserts to handle 3.1/2" Drill Pipe for Slip Body Size 4.1/2" (One set consists of 08 no. of Inserts)	4 Set
16.	5163-B	Inserts (Taper Design) to handle 3.1/2" Drill Pipe for Slip Body Size 4.1/2" (One set consists of 04 no. of Inserts)	4 Set
17.	5164	Inserts to handle 4" Drill Pipe for Slip Body Size 4.1/2" (One set consists of 08 no. of Inserts)	4 Set
18.	5164-B	Inserts (Taper Design) to handle 4" Drill Pipe for Slip Body Size 4.1/2" (One set consists of 04 no. of Inserts)	4 Set
19.	5165	Inserts to handle 4.1/2" Drill Pipe for Slip Body Size 4.1/2" (One set consists of 12 no. of Inserts)	4 Set
20.	5168	Inserts to handle 4.1/2" Drill Pipe for Slip Body Size 5.1/2" (One set consists of 08 no. of Inserts)	4 Set
21.	5168-B	Inserts (Taper Design) to handle 4.1/2" Drill Pipe for Slip Body Size 5.1/2" (One set consists of 04 no. of Inserts)	4 Set
22.	5169	Inserts to handle 5" Drill Pipe for Slip Body Size 5.1/2" (One set consists of 08 no. of Inserts)	4 Set
23.	5169-B	Inserts (Taper Design) to handle 5" Drill Pipe for Slip Body Size 5.1/2" (One set consists of 04 no. of Inserts)	4 Set
24.	5170	Inserts to handle 5.1/2" Drill Pipe for Slip Body Size 5.1/2" (One set consists of 12 no. of Inserts)	4 Set

PNEUMATIC POWER SLIP (Eq. to PS 16)

Model: ABPPS-27

Autobahn manufactures the Pneumatic Power Slip (ABPPS-27), an air-operated power slip designed to handle drill pipe and tubing with slip sizes ranging from 3.1/2" to 5.1/2", adjustable by changing inserts. The Pneumatic Power Slip can be controlled either by a lever or a foot-operated remote control valve.

Setting the Power Slip is achieved by a combination of gravity and applied air pressure, while release is facilitated solely by applied air pressure. This eliminates the need for manual setting and lifting of the slip. The Pneumatic Power Slip is compatible with 27.1/2", 37.1/2" and 49.1/2" Rotary Tables equipped with API standard Pin Drive Master Bushings.

Special Features:

1. Ergonomically designed for user-friendliness.
2. Operable by a single individual.
3. Remote control capability allows operation from a safer distance.
4. Enhances crew safety on the rig floor.

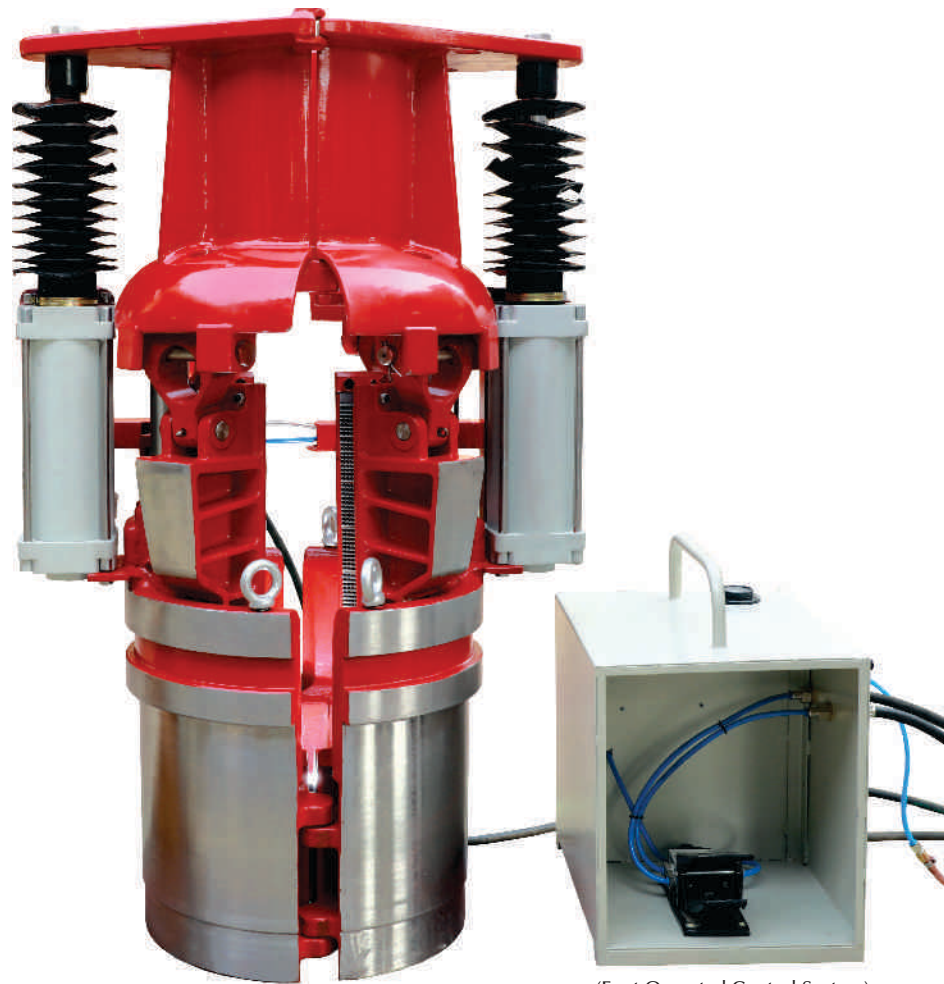

Pneumatic Power Slip
Figure No. 37

(Foot Operated Control System)

The unit consists of three major assemblies as follows:

1. Top Cover Assembly:

The Top Cover is designed in two halves and is equipped with two air cylinders connected via a ball floating joint secured with hex head screws. Mounted on four slip hangers with pins, the Top Cover Assembly facilitates smooth operation.

2. Slip Assembly:

Comprising four Slip Segments with a 16.1/2" grip length for gripping various tubular sizes, each segment is outfitted with 48 inserts, 4 insert retaining rings, and 8 Allen screws.

3. Bowl Assembly:

The Bowl Assembly, comprising two halves connected with a bowl hinge pin, enables easy installation and removal of the Power Slip from the Master Bushing. Equipped with four coil spring cartridges, it ensures efficient slip operation.

4. Air Cylinders Assembly:

This assembly includes two Air Cylinders connected to the Top Cover via floating joints. The Air Cylinders facilitate the lifting of the Top Cover Assembly along with the slip assembly.

5. Control System:

The Control System incorporates a filter/regulator, inline (pilot operated) valve, hand-operated pilot valve, quick exhaust valve, and various connecting hoses and fittings. It can be operated via Hand Control or Foot Pedal Control System for enhanced flexibility and ease of use.

Part List of Pneumatic Power Slip:

S. No.	P/N	Description	Qty. Per Unit
1.	PPS - 21	Top Cover	1 No.
2.	PPS - 22	Hose Guard	1 Set
3.	PPS - 23	Hex Head Screw	2 No.
4.	PPS - 24	Air Cylinder	2 No.
5.	PPS - 25	Floating Joint	2 No.
6.	PPS - 26	Bellow	2 No.
7.	PPS - 27	Quick Exhaust Valve	4 No.
8.	PPS - 28	Slip Hanger	4 No.
9.	PPS - 29	Slip Hanger Top Pin w/Cotter Pin	4 No.
10.	PPS - 30	Slip Hanger Bottom Pin w/Cotter Pin	4 No.
11.	PPS - 31	5.1/2" Slip Segment to handle 4.1/2"-5.1/2" Drill Pipe	4 No.
12.	PPS - 32	4.1/2" Slip Segment to handle 3.1/2"-4.1/2" Drill Pipe	4 No.
13.	PPS - 33	Spring Cartridge	4 No.
14.	PPS - 34	Slip Bowl (One set of Two pcs.)	1 Set
15.	PPS - 35	Bowl Hinge Pin	1 No.
16.	PPS - 36	Brass Bush	4 No.
17.	PPS - 37	Pneumatic Control System	1 No.
18.	PPS - 38	Pneumatic Hose Unit consists of Hoses, Couplings with Connectors	1 No.
19.	PPS - 39	Foot Pedal to operate remote control valve	1 No.
20.	PPS - 40	Lever to operate remote control valve	1 No.
21.	PPS - 41	Lifting Sling (Four Hooks Type).	1 No.
22.	5163	Inserts to handle 3.1/2" Drill Pipe for Slip Body Size 4.1/2" (One set consists of 08 no. of Inserts)	4 Set
23.	5163-B	Inserts (Taper Design) to handle 3.1/2" Drill Pipe for Slip Body Size 4.1/2" (One set consists of 04 no. of Inserts)	4 Set
24.	5164	Inserts to handle 4" Drill Pipe for Slip Body Size 4.1/2" (One set consists of 08 no. of Inserts)	4 Set
25.	5164-B	Inserts (Taper Design) to handle 4" Drill Pipe for Slip Body Size 4.1/2" (One set consists of 04 no. of Inserts)	4 Set
26.	5165	Inserts to handle 4.1/2" Drill Pipe for Slip Body Size 4.1/2" (One set consists of 12 no. of Inserts)	4 Set
27.	5168	Inserts to handle 4.1/2" Drill Pipe for Slip Body Size 5.1/2" (One set consists of 08 no. of Inserts)	4 Set
28.	5168-B	Inserts (Taper Design) to handle 4.1/2" Drill Pipe for Slip Body Size 5.1/2" (One set consists of 04 no. of Inserts)	4 Set
29.	5169	Inserts to handle 5" Drill Pipe for Slip Body Size 5.1/2" (One set consists of 08 no. of Inserts)	4 Set
30.	5169-B	Inserts (Taper Design) to handle 5" Drill Pipe for Slip Body Size 5.1/2" (One set consists of 04 no. of Inserts)	4 Set
31.	5170	Inserts to handle 5.1/2" Drill Pipe for Slip Body Size 5.1/2" (One set consists of 12 no. of Inserts)	4 Set

SAFETY CLAMPS Model: ABSC

Safety clamps are indispensable tools designed to prevent the accidental dropping of casing, Drill Collars, Tubing, and other tubulars into wellbores. By avoiding such incidents, they help prevent downtime and the need for time-consuming fishing expeditions. These clamps are typically installed above Slips or spiders during the initial phases of well installation when string loads are too light to ensure sufficient grip from slip equipment.

Featuring flexibly hinged links, each Safety Clamp contains its own die for gripping. Spring tension ensures continuous contact between the insert and clamp body, allowing the insert to move relative to the taper and better support the load. In case a pipe begins to fall, taper mountings within the clamps tighten around the pipe, halting further movement. Equipped with spring-loaded dies acting as shock absorbers, safety clamps provide additional axial support to prevent tubulars from falling into the wellbore.

Autobahn offers a diverse range of Safety Clamps tailored to fit tubulars ranging from 2.7/8" to 36" in diameter. These clamps exert uniform gripping pressure around pipes, preventing the crushing of thin-walled pipes or damage to their surfaces.



Safety Clamps
Figure No. 38

Description	ABSC-S		ABSC-R				
Size	2.7/8"-4.1/8"	4"-5"	4.1/2"-5.5/8"	5.1/2"-7"	6.3/4"-8 1/4"	8"-9.1/4"	9.1/4"-10.1/2"
P/N Complete Set	6501	6502	6503	6504	6505	6506	6507
Weight in Kg.	37.5	41	37	40	44	47.5	51
Total Links	7 No.	8 No.	7 No.	8 No.	9 No.	10 No.	11 No.
No. of Gripping Dies	8 No.	9 No.	8 No.	9 No.	10 No.	11 No.	12 No.

Description	ABSC-R				
Size	10.1/2"-11.1/2"	11.1/2"-12.1/2"	12.1/2"-13.5/8"	13.5/8"-14.3/4"	14.3/4"-15.7/8"
P/N Complete Set	6508	6509	6510	6511	6512
Weight in Kg.	55	58.5	62	66	69.9
Total Links	12 No.	13 No.	14 No.	15 No.	16 No.
No. of Gripping Dies	13 No.	14 No.	15 No.	16 No.	17 No.

Description	ABSC-L			ABSC-XL		
Size	15.7/8"-17"	17"-18.1/2"	18.1/8"-19.3/8"	19.3/8"-20.3/8"	20.3/8"-21.1/2"	21"-22.5/8"
P/N Complete Set	6513	6514	6515	6516	6517	6518
Weight in Kg.	78.5	82	86	89	92.5	96
Total Links	17 No.	18 No.	19 No.	19 No.	20 No.	21 No.
No. of Gripping Dies	18 No.	19 No.	20 No.	20 No.	21 No.	22 No.

Description	ABSC-XL						
Size	22.5/8" - 23.3/4"	23.3/4" - 24.7/8"	24.7/8"-26"	26"-27.1/8"	29.3/8"-30.1/2"	32"	36"
P/N Complete Set	6519	6520	6521	6522	6523	6524	6525
Weight in Kg.	100	103.5	107	110.5	152.5	181	185
Total Links	22 No.	23 No.	24 No.	25 No.	28 No.	31 No.	35 No.
No. of Gripping Dies	23 No.	24 No.	25 No.	26 No.	29 No.	32 No.	36 No.

UMBILICAL BOWL & ROTARY SLIPS

Autobahn has introduced an innovative Umbilical/Slotted Insert Bowl specifically designed for 27.1/2" and 37.1/2" Master Bushings. To facilitate the installation of umbilical's, a special Insert Bowl, numbered #2 and #3, featuring a single slot for maximum opening, has been developed.

1. Compatibility with SDXL/SDHL or RHS Rotary Hand Slips, resulting in a significantly larger opening for enhanced functionality.
2. Enhanced load capacity of up to 750 sTon, ensuring robust performance even under heavy loads.

Compliance with the latest edition of API 7K standards.

Part No. for Umbilical / Slotted Bowl:

Description	For 27.1/2" Master Bushing	For 37.1/2" Master Bushing
Umbilical / Slotted Insert Bowl No. 3 to handle tubular size 2.3/8" to 8.5/8"	2758-U	3753-U
Umbilical / Slotted Insert Bowl No. 2 to handle tubular size 9.5/8" to 10.3/4"	2757-U	3752-U

SDXL Umbilical / Slotted Rotary Slip

Autobahn has introduced the SDXL-Long Rotary Slip with a grip size of 16.1/2", featuring an Umbilical slot tailored for use with Umbilical/Slotted Insert Bowl No. 2 & 3.

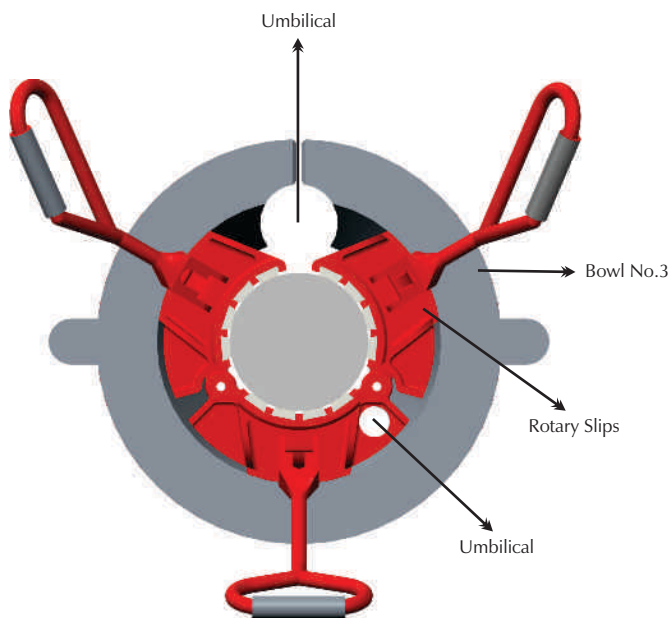

Umbilical Bowl & Rotary Slips
Figure No. 39

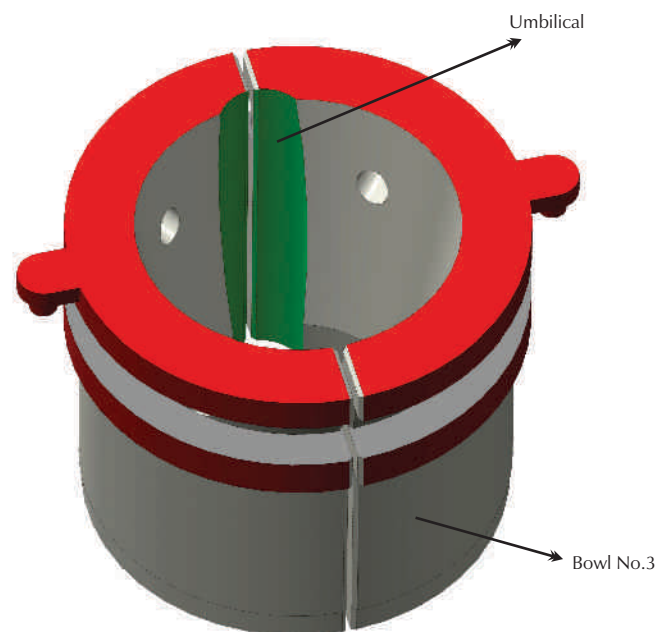

Umbilical Bowl
Figure No. 40

Note: The Umbilical Bowl and Umbilical Slip can also be customized according to customer requirements and designs upon specific orders.

VENOM SHALE SHAKERS

Autobahn's Venom Shale Shakers are engineered to deliver high-capacity separation efficiency and operational flexibility, all within a compact footprint. In today's drilling environment, where operational costs are high both Onshore and Offshore, these Shale Shakers are invaluable in reducing costly non-productive time (NPT) and ensuring compliance with stringent environmental regulations.

Designed for premium drilling fluid applications, Autobahn's Venom Shale Shakers excel in recovering valuable resources from what would otherwise be waste material. They are capable of handling a wide range of solids and fluid compositions, adapting seamlessly to changes in the rate of penetration (ROP) during drilling operations.



Single Deck Venom Shale Shaker
Model : ABI-SD-501
Figure No. 41



Dual Deck Venom Shale Shaker
Model : ABI-SD-502
Figure No. 42

Technical Specification:

S.No.	Description / Model	ABI-SD-501	ABI-SD-502	ABI-SD-503
1.	Motion	Linear	Linear	Linear
2.	No. of Deck	Single	Dual	Triple
3.	No. of screen per deck	4 No.	4 No.	4 No.
4.	Power supply	380-415V/50HZ or 460V/60HZ	380-415V/50HZ or 460V/60HZ	380-415V/50HZ or 460V/60HZ
5.	Deck Angle	-1° to +5°	-1° to +5°	-1° to +5°
6.	Dimensions in mm (L×W×H)	3100×1800×1420	3100×3870×1420	3100×6100×1420
7.	Weight	1875Kg	3750Kg	5625Kg
8.	Screen size in mm	1165×585	1165×585	1165×585
9.	Operating temperature	-20°C to +55°C	-20°C to +55°C	-20°C to +55°C
10.	Vibrating noise	75 - 85dBA	75 - 85dBA	75 - 85dBA

- Note:
1. Motors and Starters are Flame proof, Explosion Proof, Weather Proof and are compatible with specified operating conditions. Certificates such as IEC/ATEX/CE will be provided.
 2. Customized Shale Shaker are also available on request.

SUPERFLOW SHALE SHAKERS

We offer a leading range of cost-effective technologies aimed at minimizing the HSE (Health, Safety, and Environment) impact of both offshore and onshore drilling activities. Our next-generation SuperFlow Shale Shakers deliver high-performance results, featuring increased capacity and superior solids conveyance. With a compact design, these shakers ensure stable and trouble-free operation, requiring minimal maintenance.

Key Features of the SuperFlow Shale Shakers:

1. Single Side Screen Tension System enables fast screen replacement.
2. Single Point Adjustment System streamlines operation.
3. Compact design requires minimal headroom.



SuperFlow Shale Shaker
Figure No. 43

Technical Specification:

S.No.	Description / Model	ABI-SG-501	ABI-SG-502	ABI-SG-503
1.	Motion	Linear/Balanced Elliptical Motion	Linear/Balanced Elliptical Motion	Linear/Balanced Elliptical Motion
2.	No. of Deck	Single	Dual	Triple
3.	No. of screen per deck	3 No.	3 No.	3 No.
4.	Power Supply	380-415V/50HZ or 460V/60HZ	380-415V/50HZ or 460V/60HZ	380-415V/50HZ or 460V/60HZ
5.	Deck Angle	-1° to +5°	-1° to +5°	-1° to +5°
6.	Weight	1900Kg	3900Kg	5700Kg
7.	Dimensions in mm (L×W×H)	2800×1765×1540	2800×3900×1540	2800×6200×1540
8.	Screen size in mm	1050×697	1050×697	1050×697

S.No.	Description / Model	ABI-SG-504	ABI-SG-505	ABI-SG-506
1.	Motion	Linear/Balanced Elliptical Motion	Linear/Balanced Elliptical Motion	Linear/Balanced Elliptical Motion
2.	No. of Deck	Single	Dual	Triple
3.	No. of screen per deck	4 No.	4 No.	4 No.
4.	Power Supply	380-415V/50HZ or 460V/60HZ	380-415V/50HZ or 460V/60HZ	380-415V/50HZ or 460V/60HZ
5.	Deck Angle	-1° to +7°	-1° to +7°	-1° to +7°
6.	Weight	2400Kg	4800Kg	7200Kg
7.	Dimensions in mm (L×W×H)	3500×1765×1540	3500×3900×1540	3500×6200×1540
8.	Screen size in mm	1050×697	1050×697	1050×697

MUD CLEANERS

Autobahn Mud Cleaners utilize a two-stage separation process to enhance drilling fluid recovery. This design enables our mud cleaners to handle the entire circulating volume, remove dry solids, and retain premium base fluid, which is vital for drilling success.

The two-stage process combines Desander and Desilter hydrocyclones, mounted over a shale shaker, to operate as a single unit. The hydrocyclones perform the primary separation, with the underflow directed onto the shaker screen.

Our mud cleaners are effective for both weighted and unweighted drilling fluids, helping to lower fluid expenses and disposal costs. Autobahn Mud Cleaners enhance drilling efficiency and productivity by optimizing fluid recovery and minimizing waste.



Mud Cleaner
Figure No. 44

Technical Specification:

S.No.	Model	ABI-MD-401	ABI-MD-402	ABI-MD-403
1.	Capacity	≤240m ³ /h(1056GPM)	≤240m ³ /h(1056GPM)	≤360m ³ /h(1584GPM)
2.	DESANDERS Hydrocyclone	2x10" (250mm)	2x10" (250mm)	3x10" (250mm)
3.	DESILTERS Hydrocyclone	12x4" (100mm)	12x4" (100mm)	16x4" (100mm)
4.	Pump Capacity	55kw (73hp)	55kw (73hp)	75kw (100hp)
5.	G-force	≤8.0Gs	≤8.0Gs	≤8.0Gs
6.	Deck Adjustment	-1° to +5°	-1° to +5°	-1° to +5°
7.	Screen Size	585x1165mm	585x1165mm	700x1250mm
8.	Screen Qty	4pcs	3pcs	3pcs
9.	Weight	1980Kg	1768Kg	2230Kg
10.	Dimension (mm)	2615x1965x2240	2030x965x2240	2403x1965x2240
11.	Power	220-240V/50Hz, 380-415V/50Hz, 440-480V60Hz, 575-600V/60Hz		
12.	Certification	IEC/UL/ATEX/CE		
13.	Remark	<ol style="list-style-type: none"> 1. Shaker motor type selection can be configured according to customer requirements. 2. The shaker screen can be selected based on customer requirements, including iron frame, composite material, or plate wave screen. 3. The treatment capacity of the equipment is measured with the following parameters: mud density of 1.2 g/cm³, mud viscosity of 45 s, and screen mesh of 40 mesh. 		

SHALE SHAKER SCREENS

S.No.	Shale Shaker Model	Screen Type	Screen Range	Dimension in mm (L x W)	Screen Model
1.	Venom Shale Shaker	Flat Type	API 20 to API 325	1165 x 585	SCREEN VS-A
2.	Venom Shale Shaker	Flat Type	API 20 to API 325	1165 x 585	SCREEN VS-B
3.	Venom Shale Shaker	Corrugated Type	API 20 to API 325	1165 x 585	SCREEN VS-C
4.	SuperFlow Shale Shaker	Flat Type	API 20 to API 325	1050 x 697	SCREEN SF-A
5.	SuperFlow Shale Shaker	Corrugated Type	API 20 to API 325	1050 x 697	SCREEN SF-B
6.	HyperFlow Shale Shaker	Corrugated Type	API 20 to API 325	1070 x 570	SCREEN HF-A

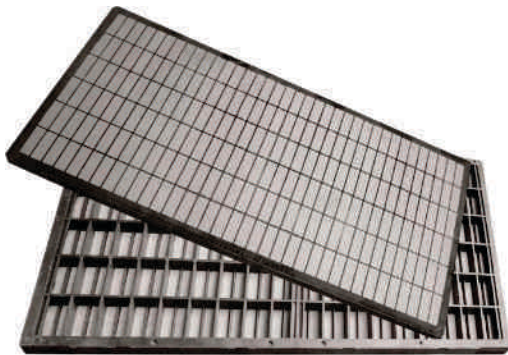

Screen for Venom Shale Shakers
Model : SCREEN VS-A
Figure No. 45

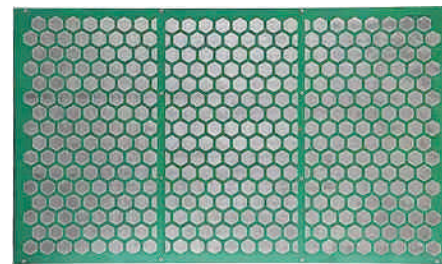

Screen for Venom Shale Shakers (Steel Frame)
Model : SCREEN VS-B
Figure No. 46

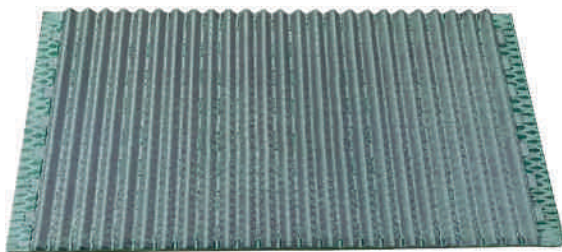

Screen for Venom Shale Shakers
Model : SCREEN VS-C
Figure No. 47

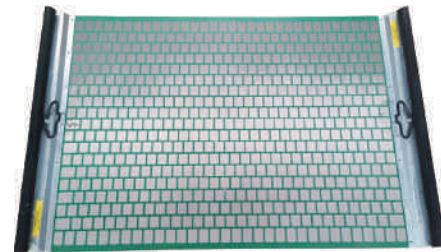

Screen for SuperFlow Shale Shakers
Model : SCREEN SF-A
Figure No. 48

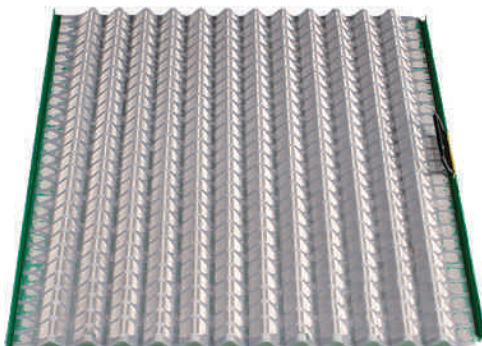

Screen for SuperFlow Shale Shakers
Model : SCREEN SF-B
Figure No. 49

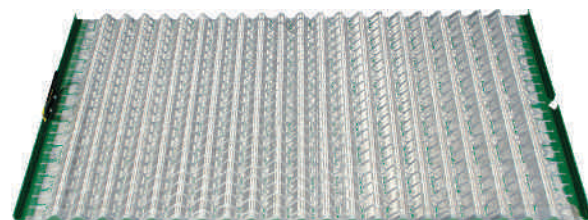

Screen for HyperFlow Shale Shakers
Model : SCREEN HF-A
Figure No. 50

Note: All the screens are manufactured in compliance with API RP 13C.

MUD AGITATORS

Autobahn Industries offers a comprehensive range of horizontal and vertical mud agitators, with horsepower ratings spanning from 3 to 30. Each unit features an explosion-proof motor coupled to a gearbox, which drives the impeller and shaft to deliver efficient fluid circulation and agitation. The mechanical configuration, horsepower impeller diameter, and shaft length are customized to tank dimensions and maximum mud weights.

The primary objectives of our meticulously designed mud agitators are to achieve:

1. Uniform suspension of all solids
2. Optimal application of shear
3. Homogeneous fluid properties throughout the system
4. Economical use of power

By meeting these key performance indicators, our mud agitators ensure optimal performance, reliability, and efficiency.



Mud Agitator
Figure No. 51

Technical Specification:

S.No.	Model	ABI-MA-2.2	ABI-MA-3	ABI-MA-5.5	ABI-MA-7.5	ABI-MA-11	ABI-MA-15	ABI-MA-18.5	ABI-MA-22
1.	Power	2.2kw	3kw	5.5kw	7.5kw	11kw	15kw	18.5kw	22kw
2.	Impeller Speed (RPM)	60/72	60/72	60/72	60/72	60/72	60/72	60/72	60/72
3.	Impeller Dia (mm)	350	350	600	750/750	850/750	950/850	950/850	1000/950
4.	Ratio	1:25/1:20 and other	1:25/1:20 and other	1:25/1:20 and other	1:25/1:20 and other	1:25/1:20 and other	1:25/1:20 and other	1:25/1:20 and other	1:25/1:20 and other
5.	Dimension (mm)	350x270 x335	420x330 x375	870x600 x560	906x600 x560	1075x650 x630	1170x720 x685	1270x1000 x727	1270x1000 x727
6.	Electric specs	220-240v/50Hz, 380-415V/50Hz, 440-480V/60Hz, 575-600V/60Hz							
7.	Shaft Length	It depends on the depth of the mud tank							
8.	Certification	IEC/UL/ATEX/CE							
9.	Remark	<ol style="list-style-type: none"> 1. Motor and bearings can be selected according to customer requirements. 2. Different power agitators can be chosen based on the density and viscosity of the stirring medium and the stirring volume. 3. The connection type between the agitator and motor can be selected according to customer requirements Vertical or Horizontal. 							

DIES & INSERTS

At our company, we leverage customized manufacturing techniques to ensure the highest quality, perfect fit, and extended lifespan for our dies and inserts. Our commitment to excellence is reflected in every step of the process, from superior material selection and precision machining to exceptional heat treatment and stress relief procedures. Our decades of experience in die and insert specialization further enhance the quality of our products.

The innovative design of Autobahn dies and inserts leads to enhanced performance and reduced maintenance costs. By integrating functionality and innovation into traditional die and insert designs, we create products that perform better, last longer, and are more cost-effective.

Our extensive product range includes dies, inserts, and spare parts for a variety of oilfield handling tools, such as:

1. Rotary Slips
2. Drill Collar Slips
3. Casing Slips
4. Safety Clamps
5. Manual Tongs
6. Tubing Spiders
7. Power Tongs

We also offer the capability to manufacture customized dies to meet specific requirements.

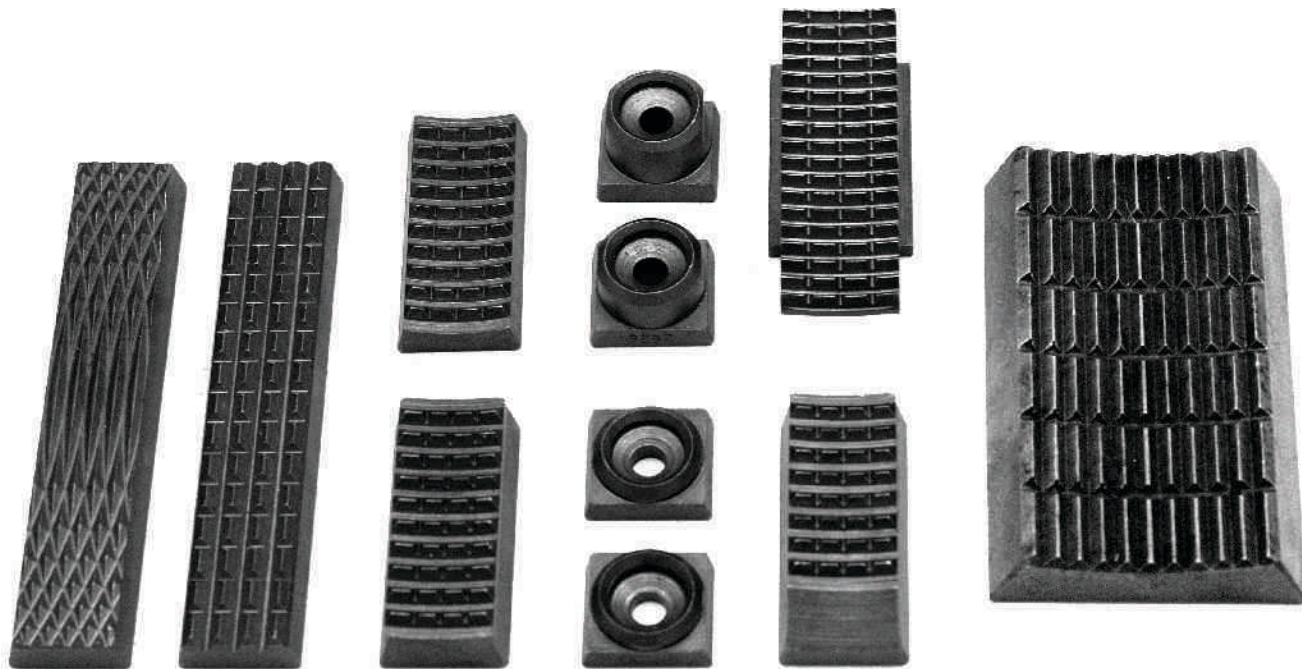

Different Types of Dies & Inserts
Figure No. 52

LIFTING SLINGS AND BIT BREAKER ADAPTER PLATE



For MPCH Master Bushing 37.1/2"
Figure No. 53



For Kelly Bushing & Power Slip
Figure No. 54



For Casing Bushings
Figure No. 55



For Insert Bowls
Figure No. 56



Bit Breaker Adapter Plate
Figure No. 57



PDC Bit Breaker
Figure No. 58

EXPERIENCE

SUPERIOR QUALITY





AUTOBAHN INDUSTRIES
company with innovation



E-4/34, Heavy Industrial Area, Alcobex Road,
JODHPUR - 342 003 (Raj.) INDIA



+91 80031 75000
+91 89552 19435



info@autobahnindustries.com
autobahnjod@yahoo.com



www.autobahnindustries.com



Catalogue



Website